

620 x 1680mm
 Minimální rozměry
 Min. size
 Min. Ausmass
 Dimension minimales

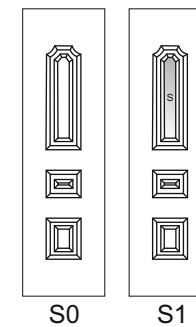
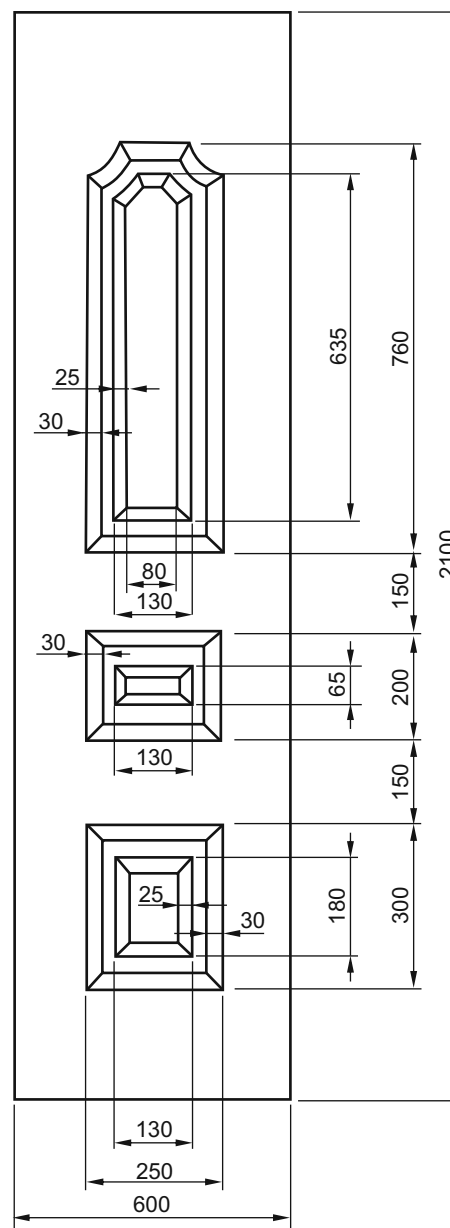

370 x 1680mm
 Minimální rozměry
 Min. size
 Min. Ausmass
 Dimension minimales

Achát

Achát 1/2

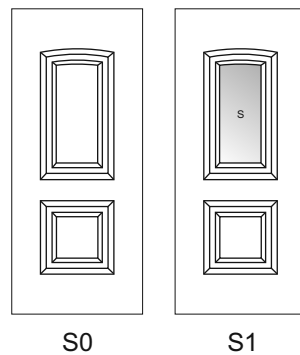
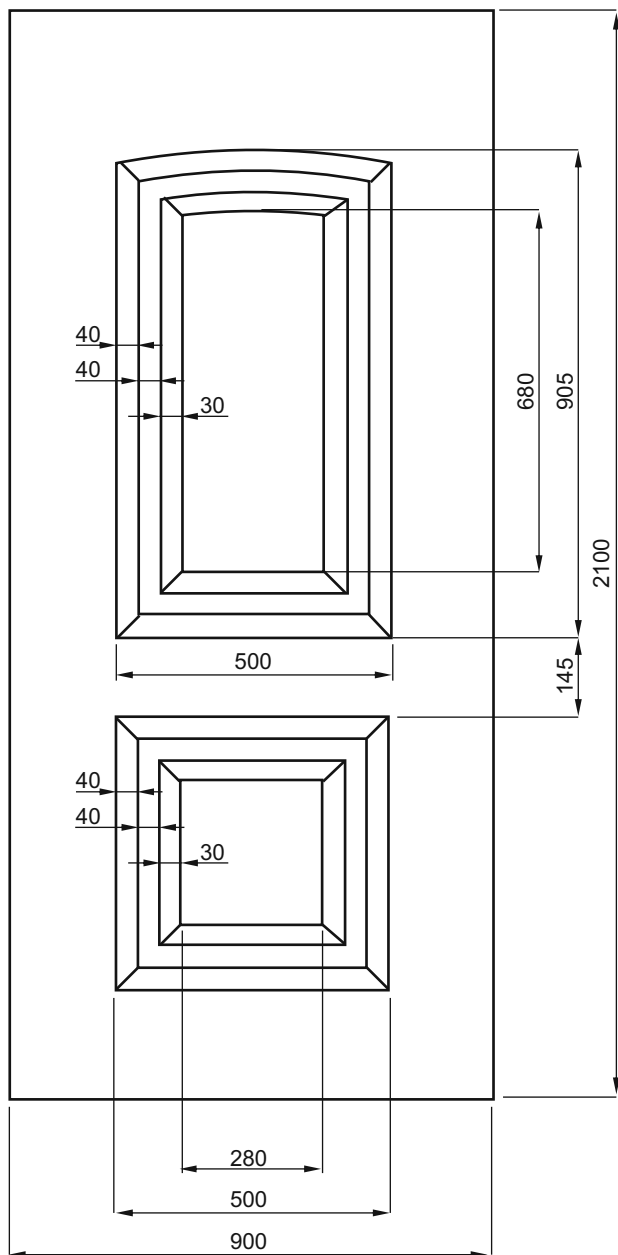

620 x 1680mm
 Minimální rozměry
 Min. size
 Min. Ausmass
 Dimension minimales

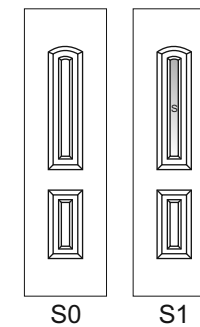
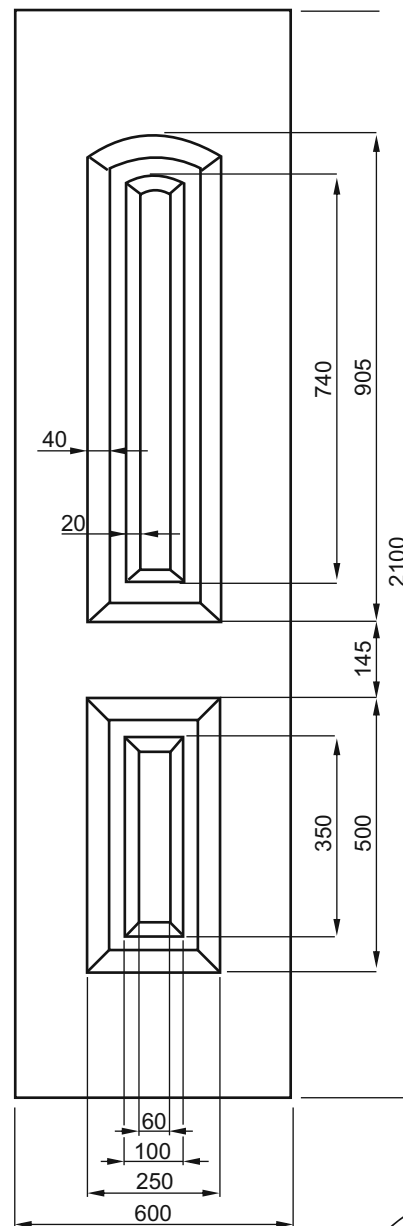

370 x 1680mm
 Minimální rozměry
 Min. size
 Min. Ausmass
 Dimension minimales

Ametyst

Ametyst 1/2

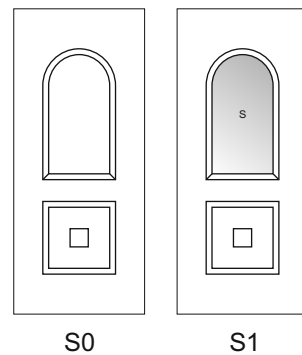
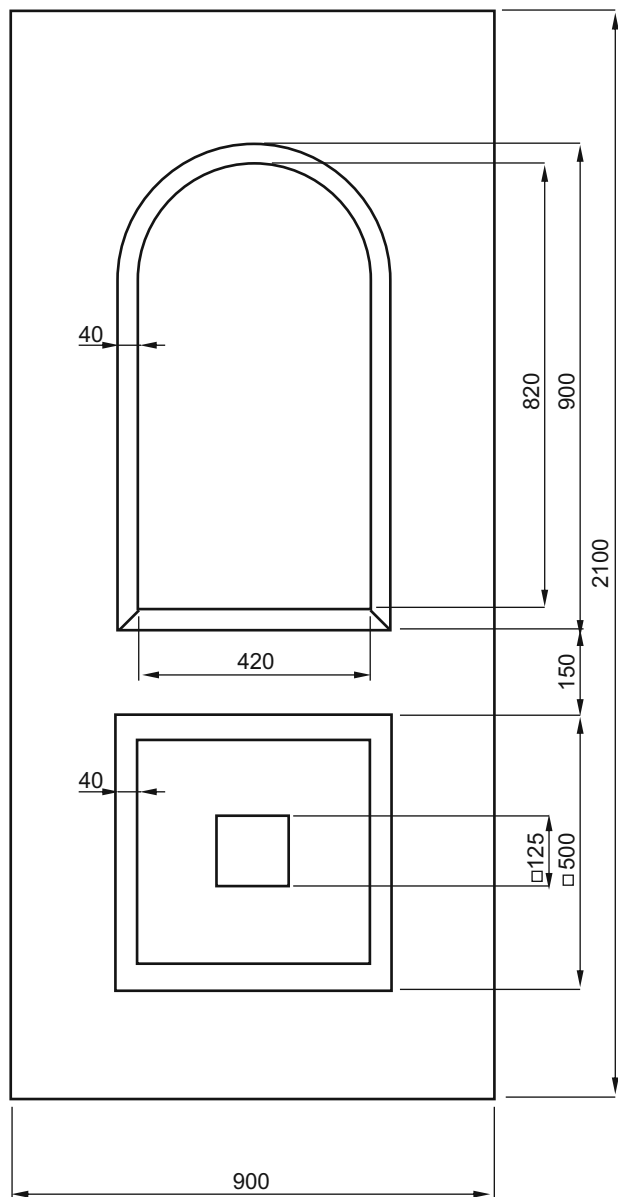

620 x 1680mm
 Minimální rozměry
 Min. size
 Min. Ausmass
 Dimension minimales

Azurit

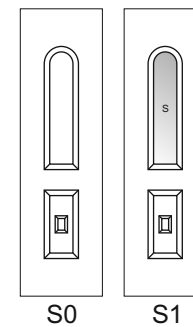
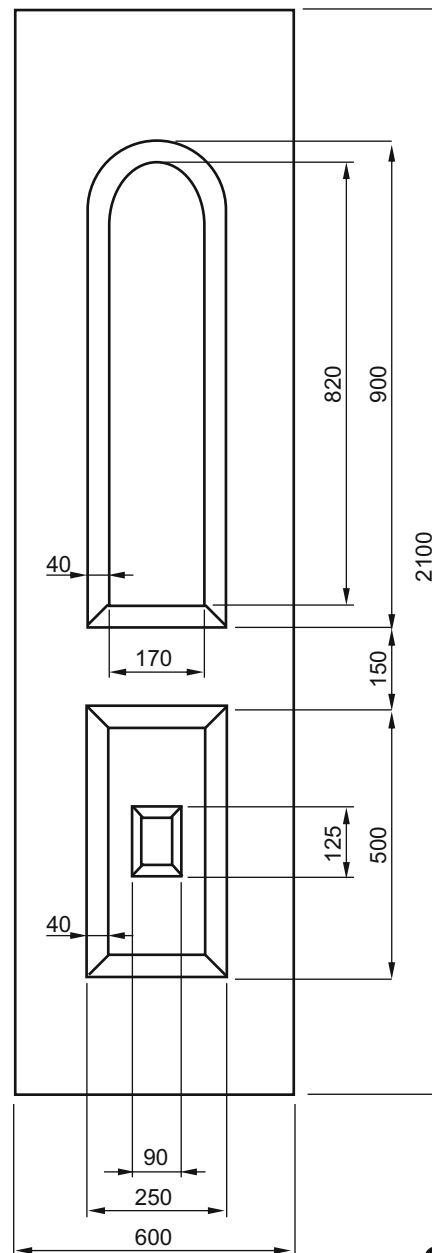

370 x 1680mm
 Minimální rozměry
 Min. size
 Min. Ausmass
 Dimension minimales

Azurit 1/2

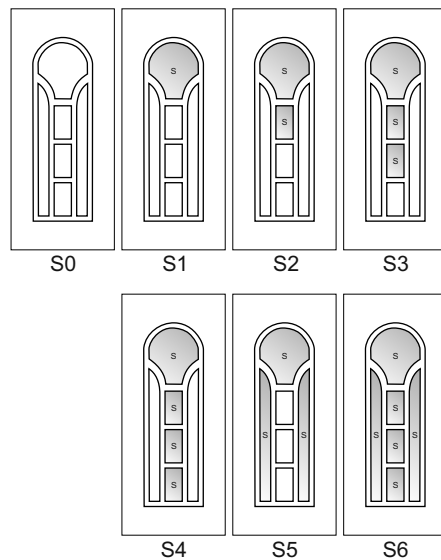
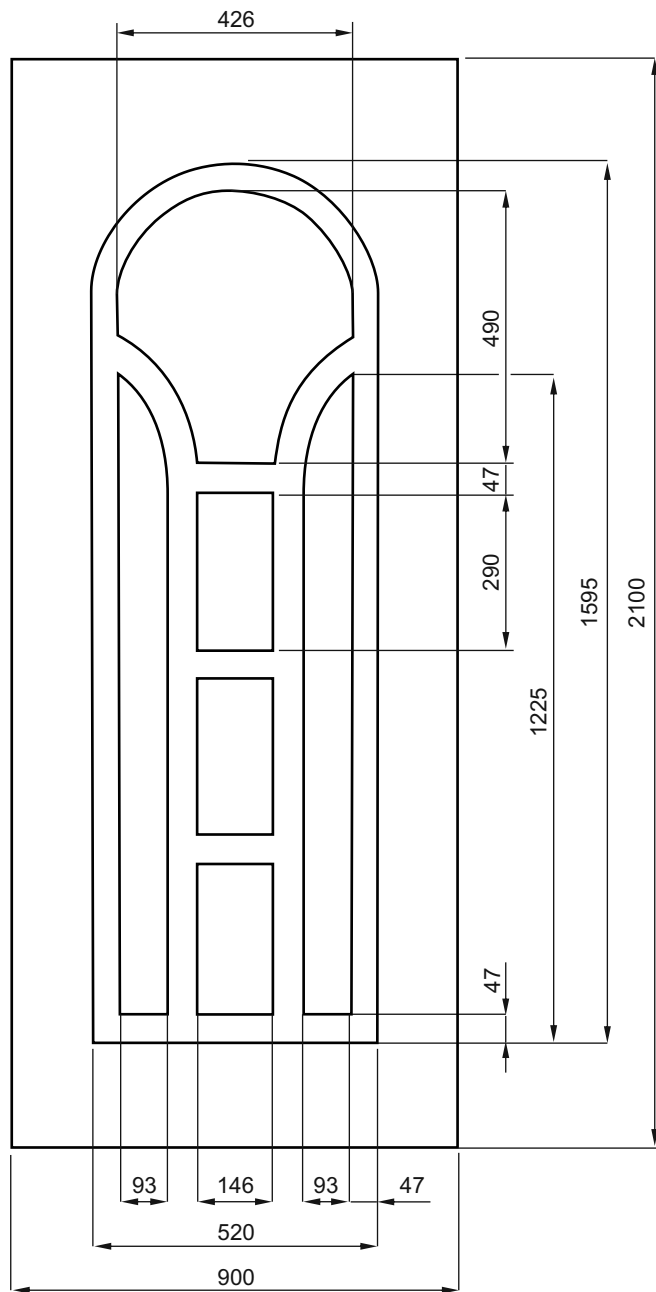

620 x 1680mm
 Minimální rozměry
 Min. size
 Min. Ausmass
 Dimension minimales

Beryl

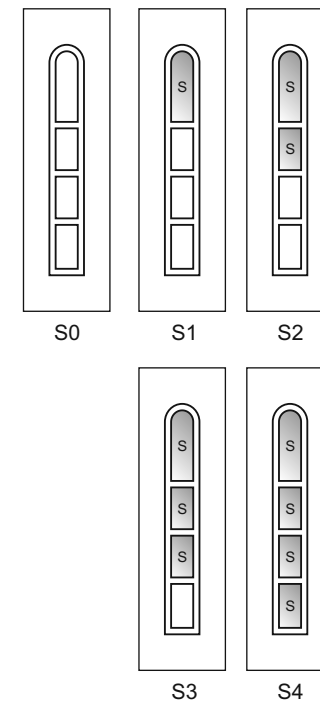
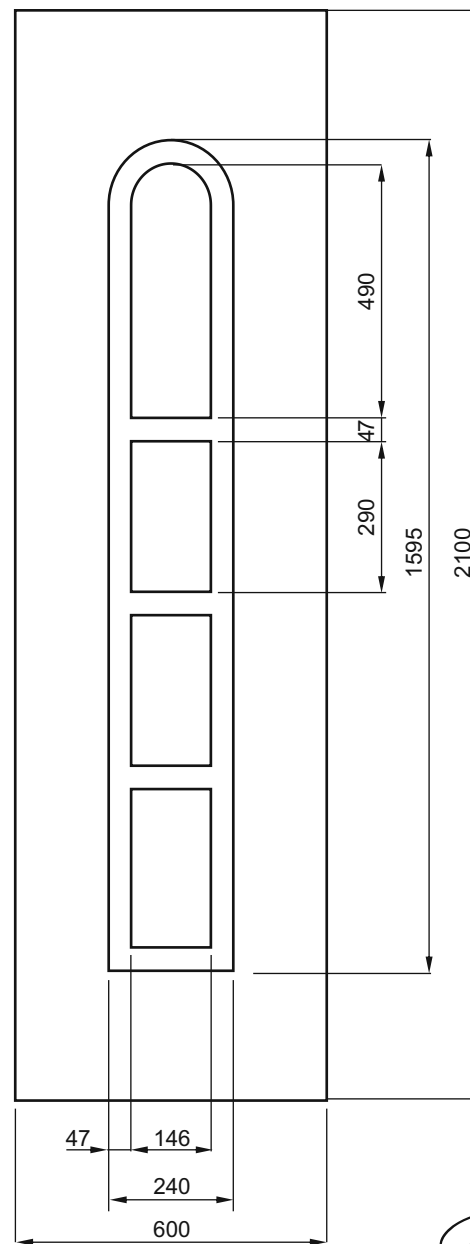

340 x 1680mm
 Minimální rozměry
 Min. size
 Min. Ausmass
 Dimension minimales

Beryl 1/2

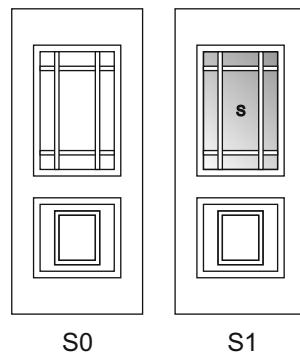
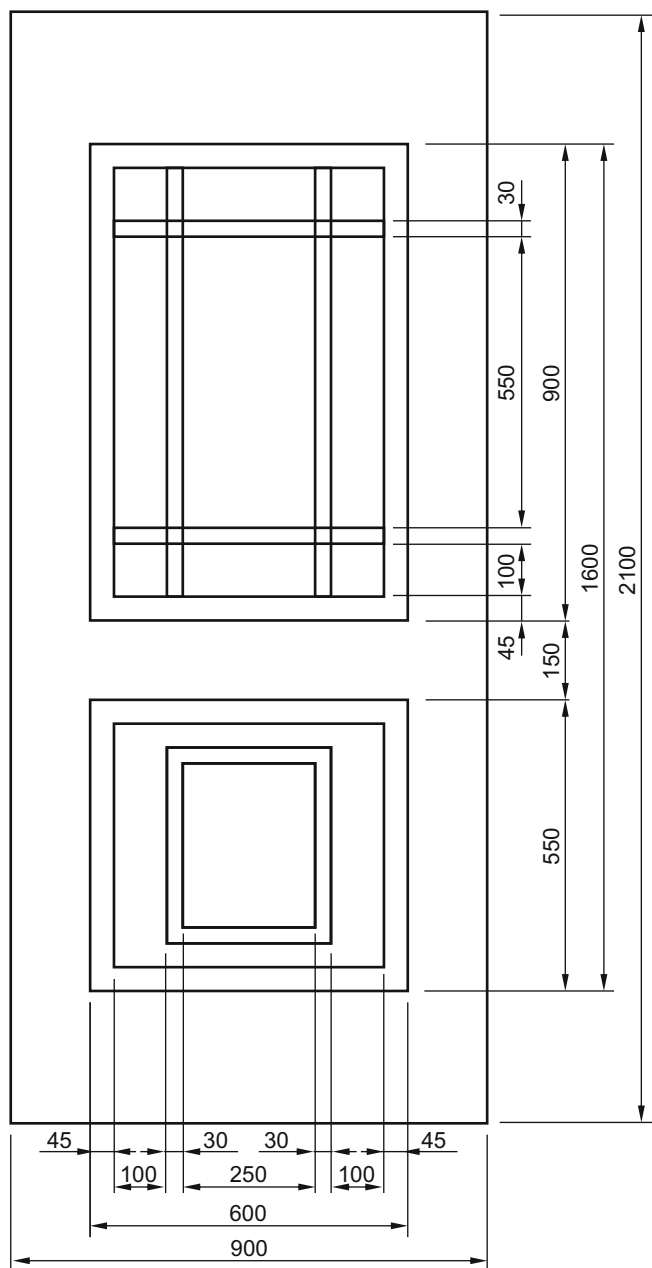

680 x 1670mm
 Minimální rozměry
 Min. size
 Min. Ausmass
 Dimension minimales

Bílina

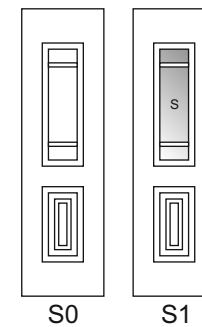
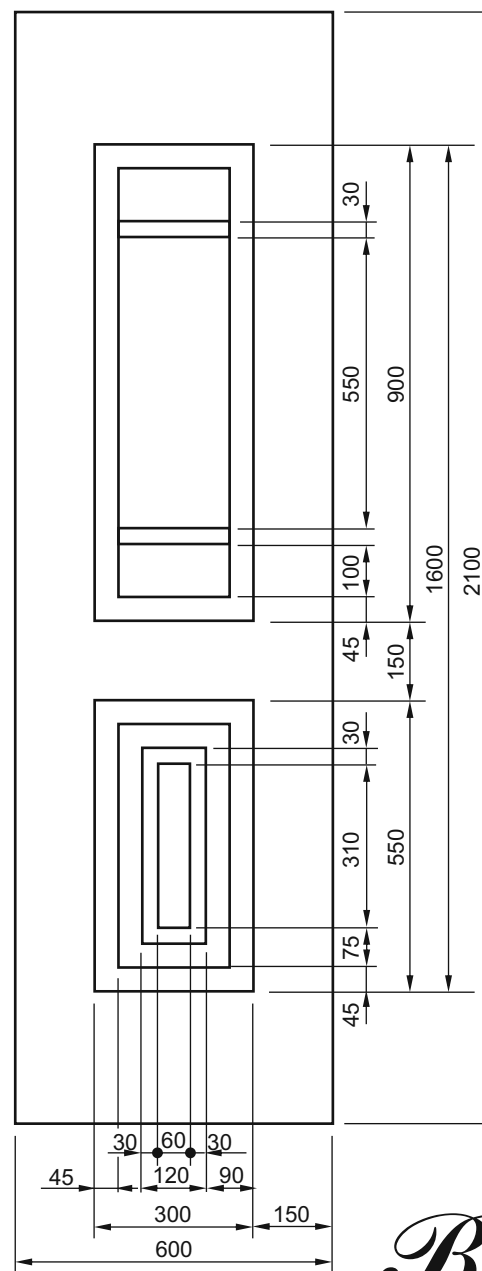

385 x 1670mm
 Minimální rozměry
 Min. size
 Min. Ausmass
 Dimension minimales

Bílina 1/2

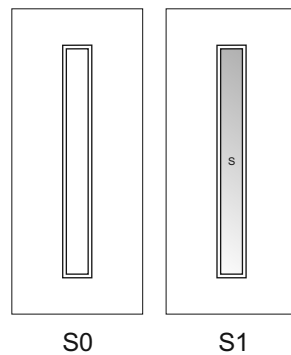
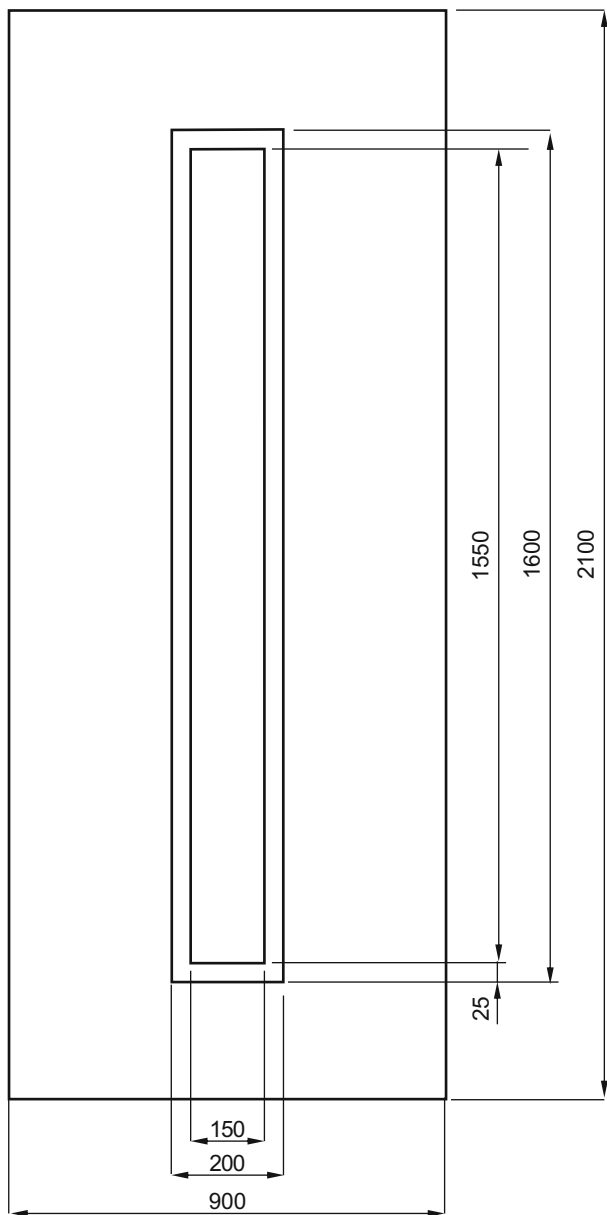

601 x 1680mm
 Minimální rozměry
 Min. size
 Min. Ausmass
 Dimension minimales

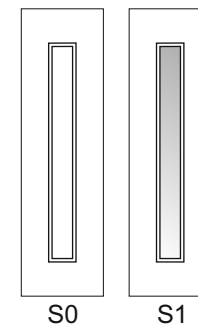
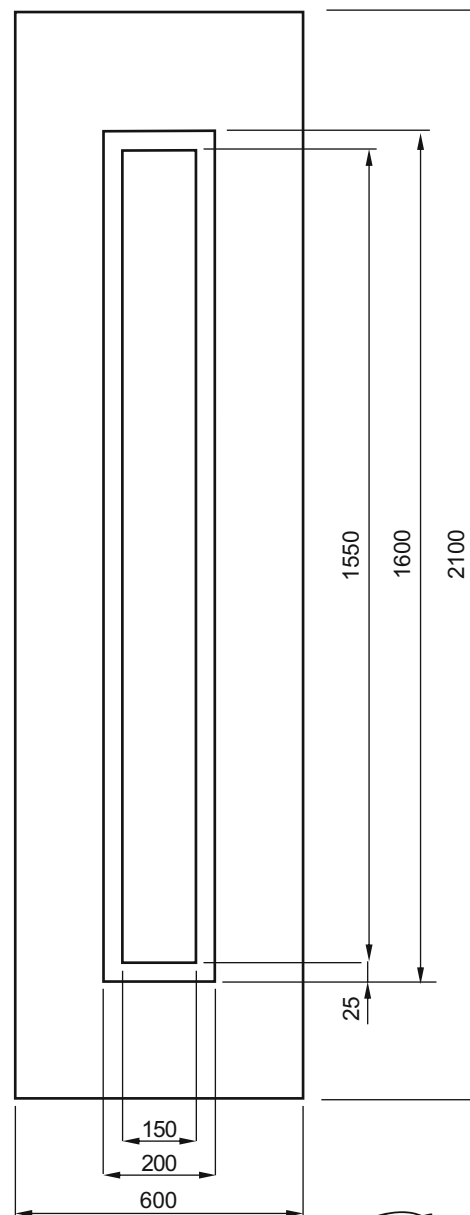

280 x 1680mm
 Minimální rozměry
 Min. size
 Min. Ausmass
 Dimension minimales

Blanice

Blanice 1/2

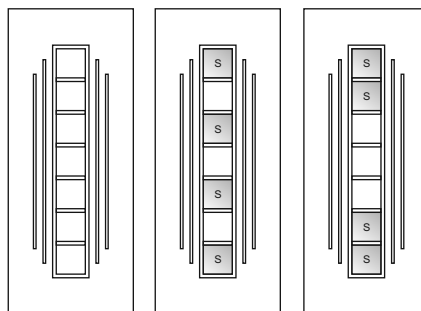
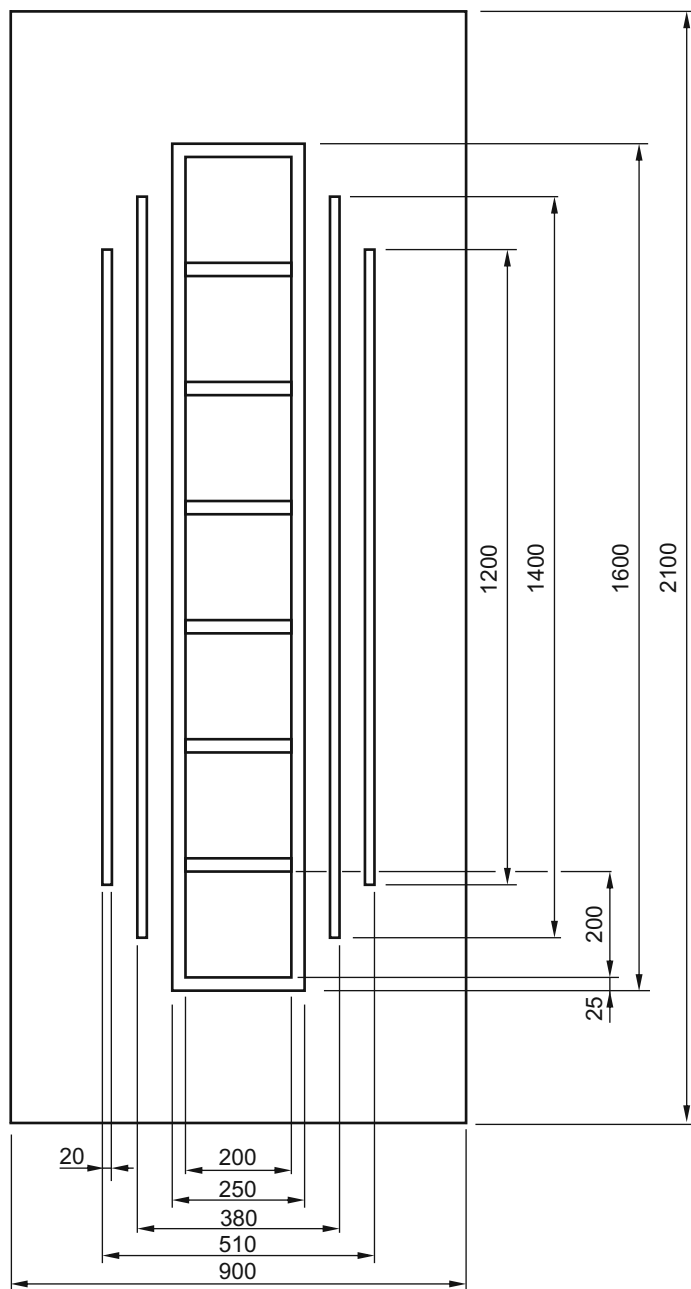

S0

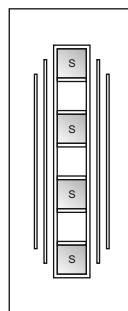

S1

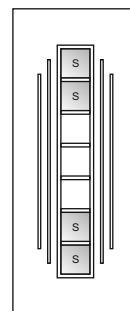

S2

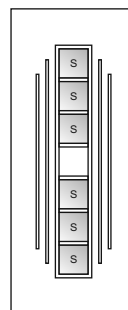

S3

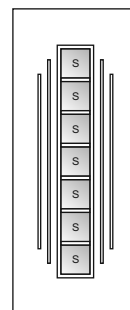

S4

600 x 1670mm
 Minimální rozměry
 Min. size
 Min. Ausmass
 Dimension minimales

Cidlina

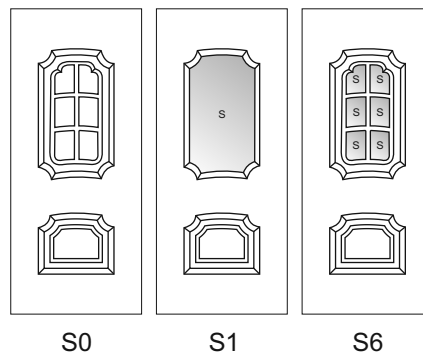
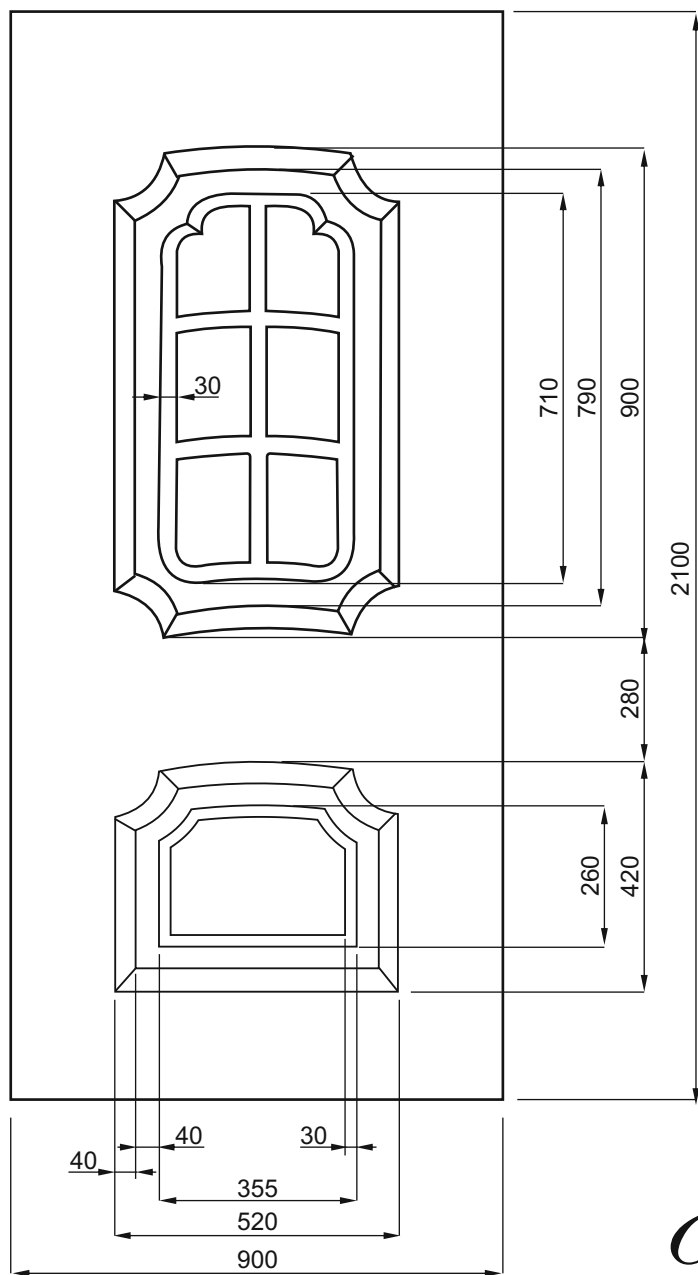

640 x 1680mm
 Minimální rozměry
 Min. size
 Min. Ausmass
 Dimension minimales

Diamant

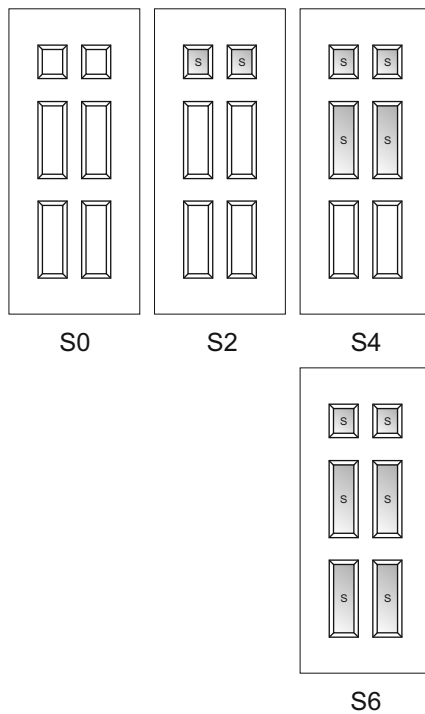
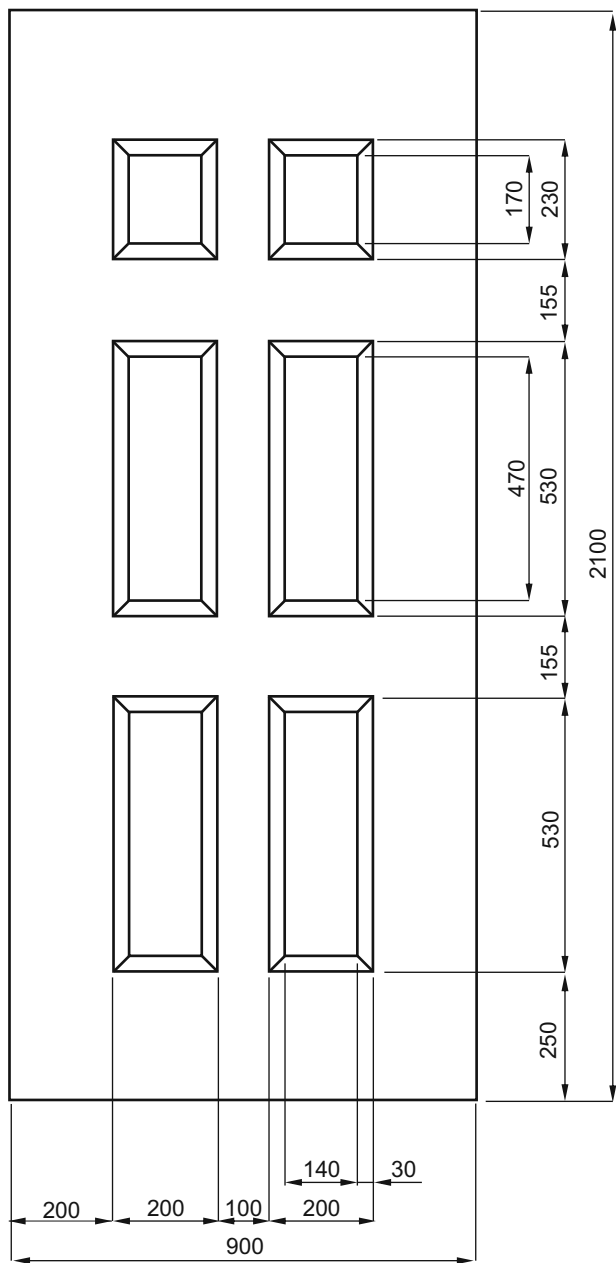

620 x 1730mm
 Minimální rozměry
 Min. size
 Min. Ausmass
 Dimension minimales

Dolomit

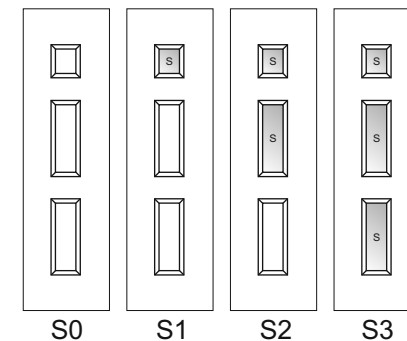
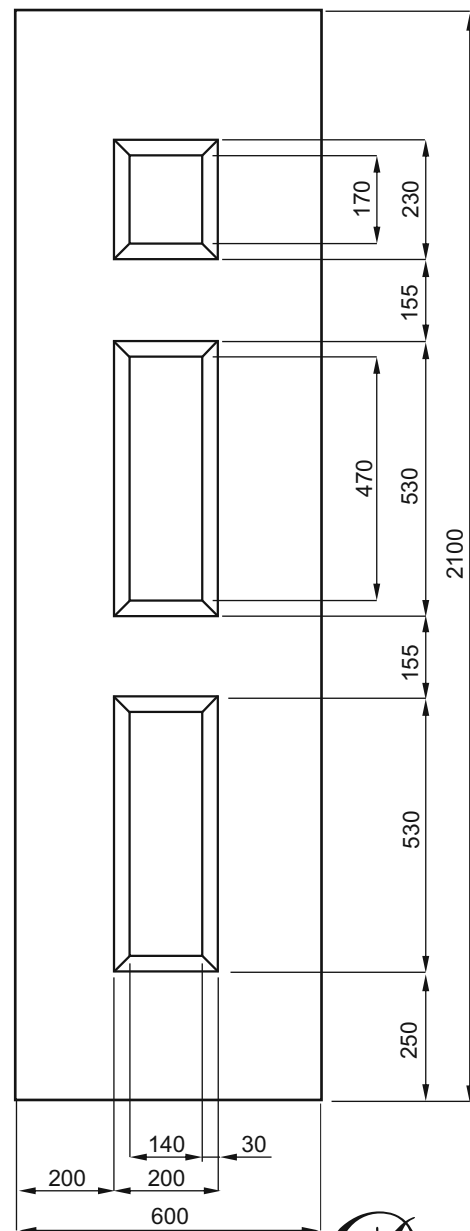

330 x 1730mm
 Minimální rozměry
 Min. size
 Min. Ausmass
 Dimension minimales

Dolomit 1/2

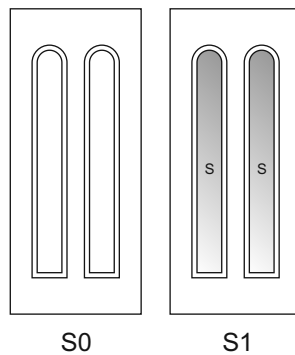
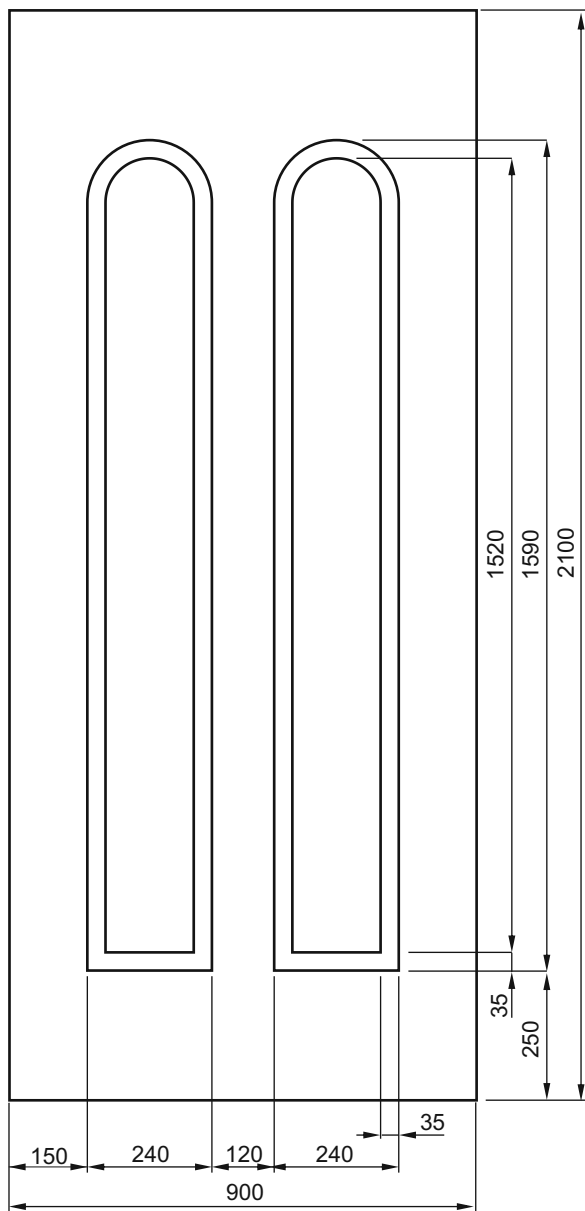

680 x 1680mm
 Minimální rozměry
 Min. size
 Min. Ausmass
 Dimension minimales

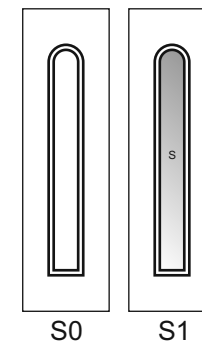
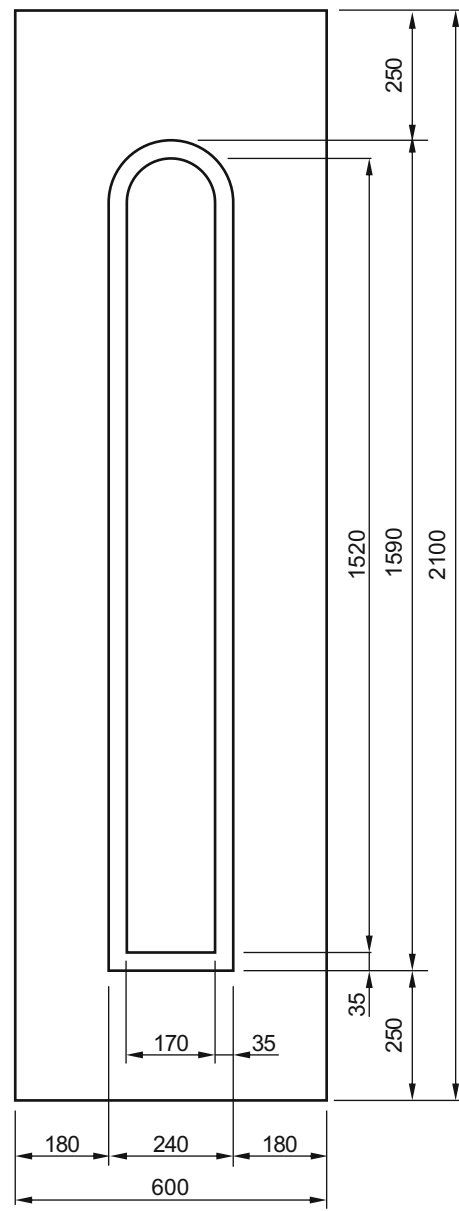

320 x 1680mm
 Minimální rozměry
 Min. size
 Min. Ausmass
 Dimension minimales

Dyje

Dyje 1/2

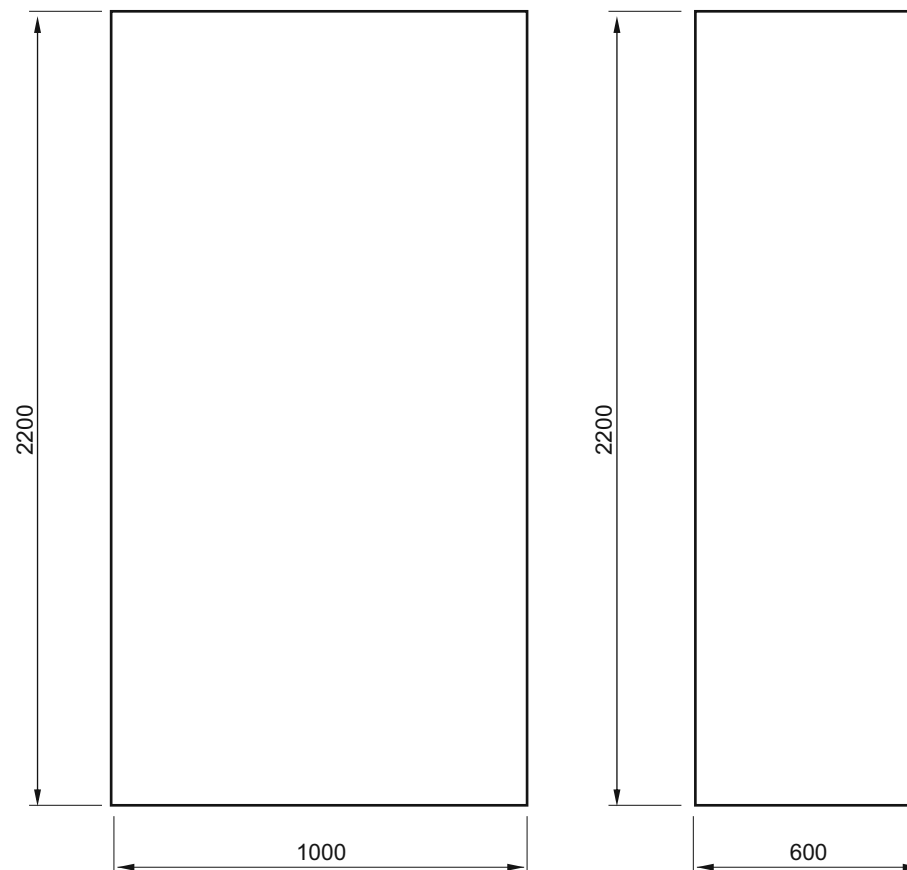

max. šířka výplně s dřevodekorem = 940 mm
max. width of door panel with wood pattern
max. Breite der Füllung mit Holzdekor
largeur max. avec décor en bois (avec décor)

Hladké výplně (bez reliéfu)
smooth panels, glatte Füllungen, panneau lisse

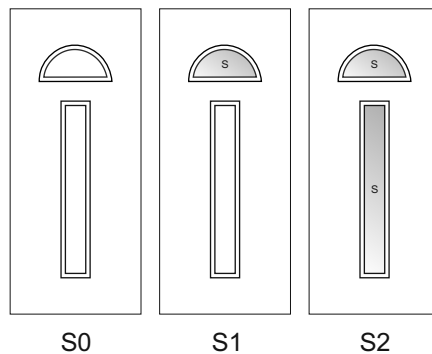
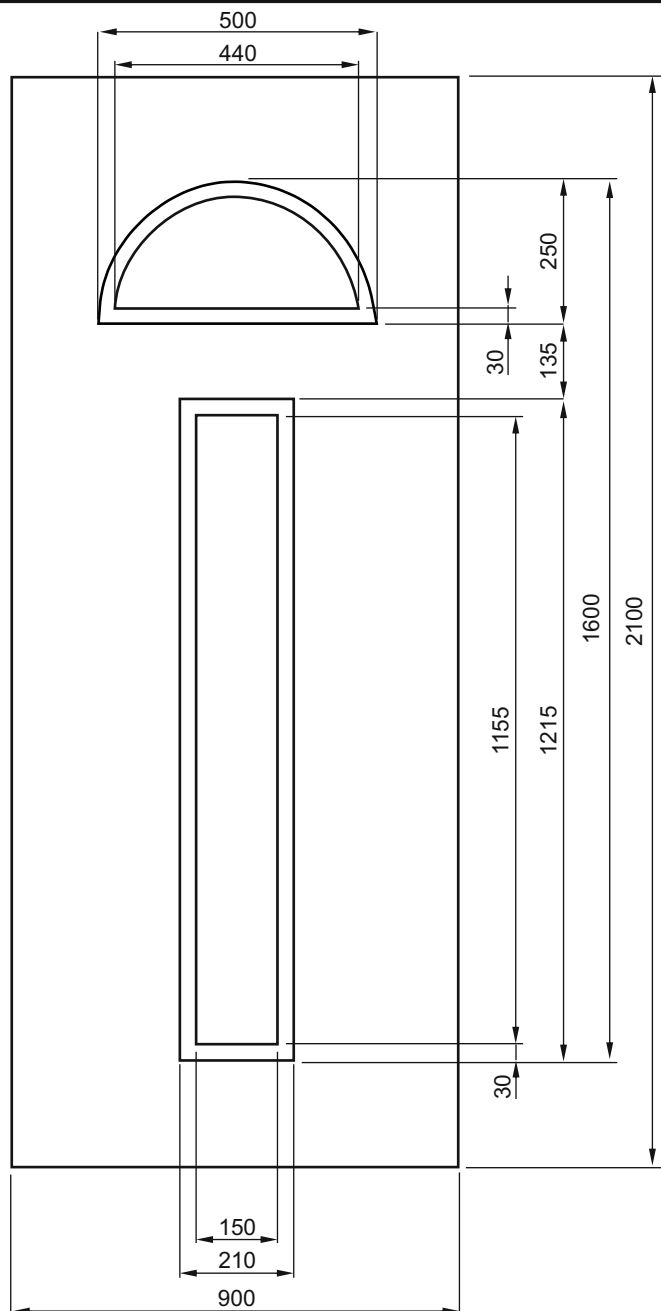

PRO PŘÍPAD POTŘEBY PŮLOVÉHO FORMÁTU
JE DOPORUČENA KOMBINACE S VÝPLNÍ **BLANICE 1/2**.

IF A HALF FORMAT NEEDED, A COMBINATION
WITH THE DOOR PANEL **BLANICE 1/2** IS RECOMMENDED.

FÜR DEN BEDARF EINES HALBFORMATES WIRD EINE
KOMBINATION MIT DER FÜLLUNG **BLANICE 1/2** EMPFOHLEN.

EN CAS DE BESOIN D'UN DEMI-FORMAT ON RECOMMANDE
LA COMBINAISON DE PANNEAU DE PORTE **BLANICE 1/2**.

580 x 1680mm
Minimální rozměry
Min. size
Min. Ausmass
Dimension minimales

Jantar

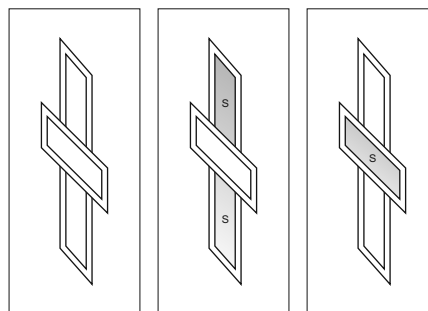
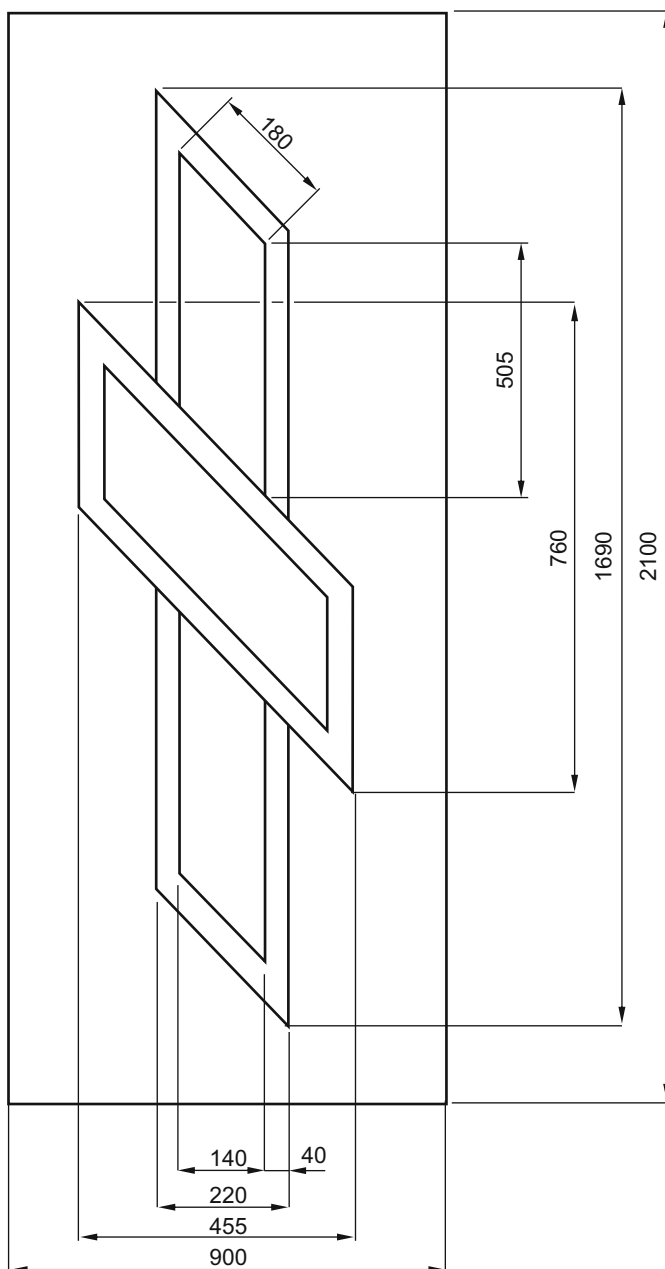

S0

S1

S2

S3

535 x 1770mm

Minimální rozměry

Min. size

Min. Ausmass

Dimension minimales

PRO PŘÍPAD POTŘEBY PŮLOVÉHO FORMÁTU
JE DOPORUČENA KOMBINACE S VÝPLNÍ **LITAVKA 1/2**.

IF A HALF FORMAT NEEDED, A COMBINATION
WITH THE DOOR PANEL **LITAVKA 1/2** IS RECOMMENDED.

FÜR DEN BEDARF EINES HALBFORMATES WIRD EINE
KOMBINATION MIT DER FÜLLUNG **LITAVKA 1/2** EMPFOHLEN.

EN CAS DE BESOIN D'UN DEMI-FORMAT ON RECOMMANDE
LA COMBINAISON DE PANNEAU DE PORTE **LITAVKA 1/2**.

Jaspis

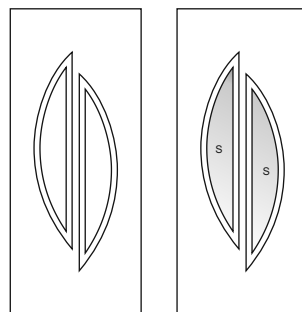
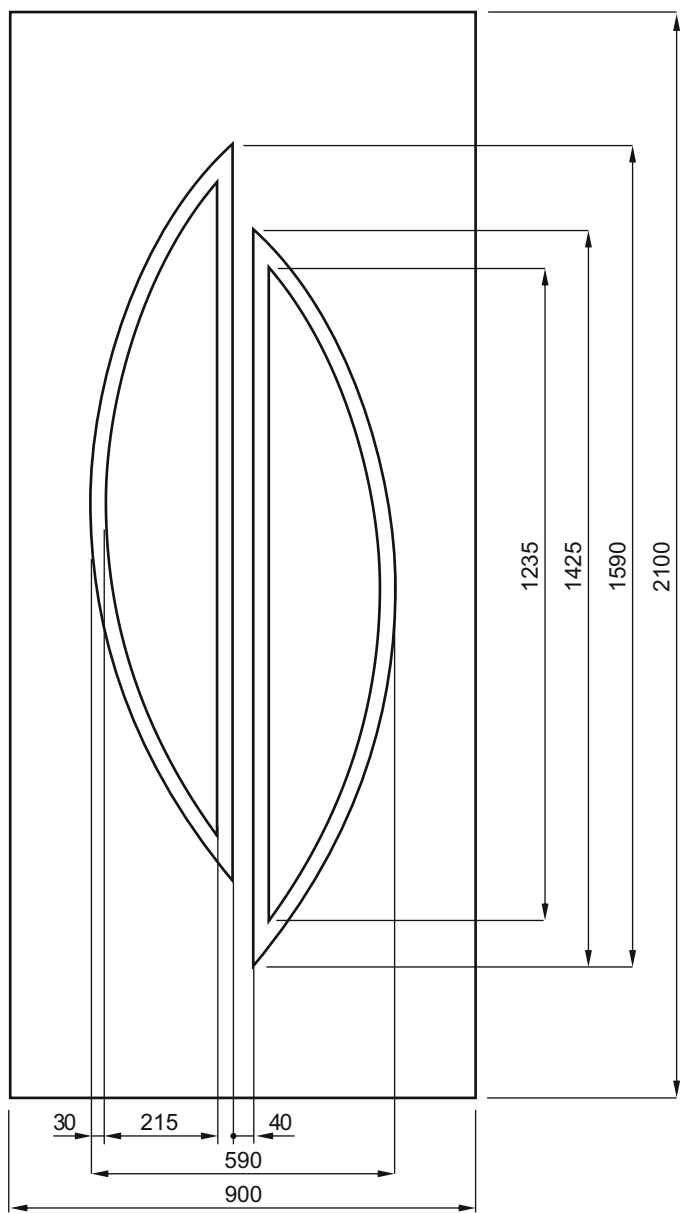

S0

S2

670 x 1670mm

Minimální rozměry

Min. size

Min. Ausmass

Dimension minimales

Jizera

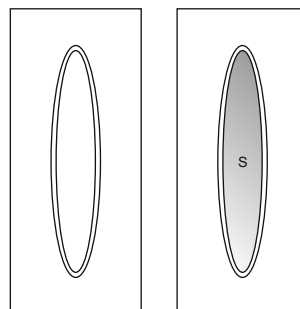
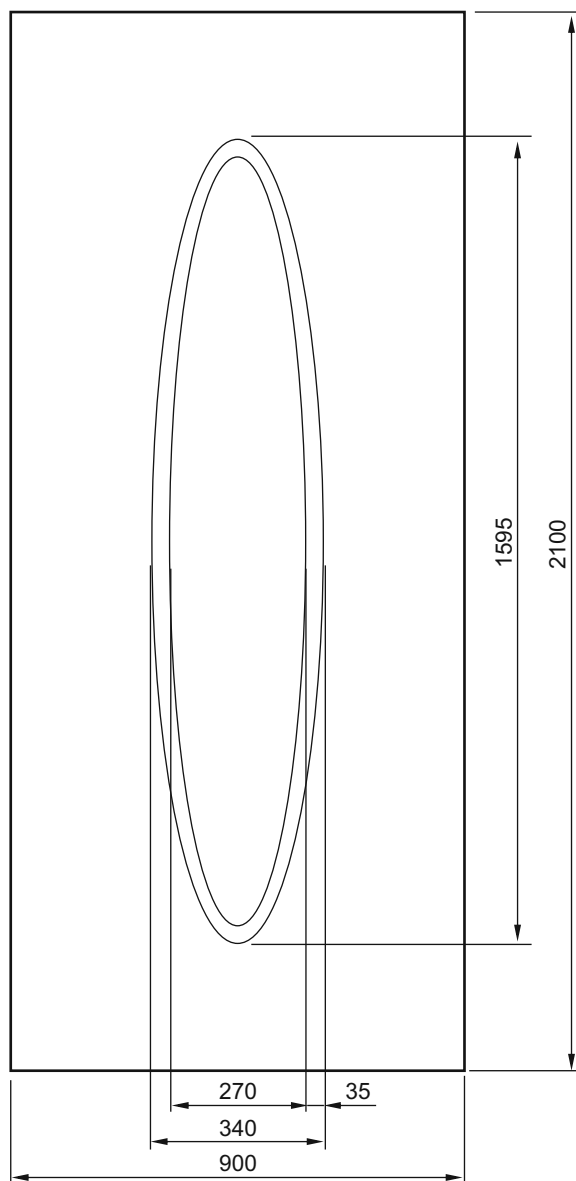

S0

S1

420 x 1680mm

Minimální rozměry

Min. size

Min. Ausmass

Dimension minimales

Karneol

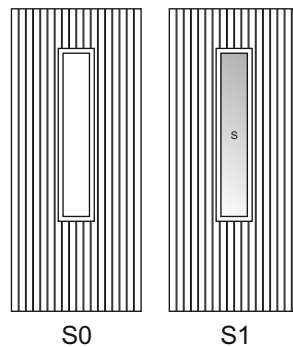
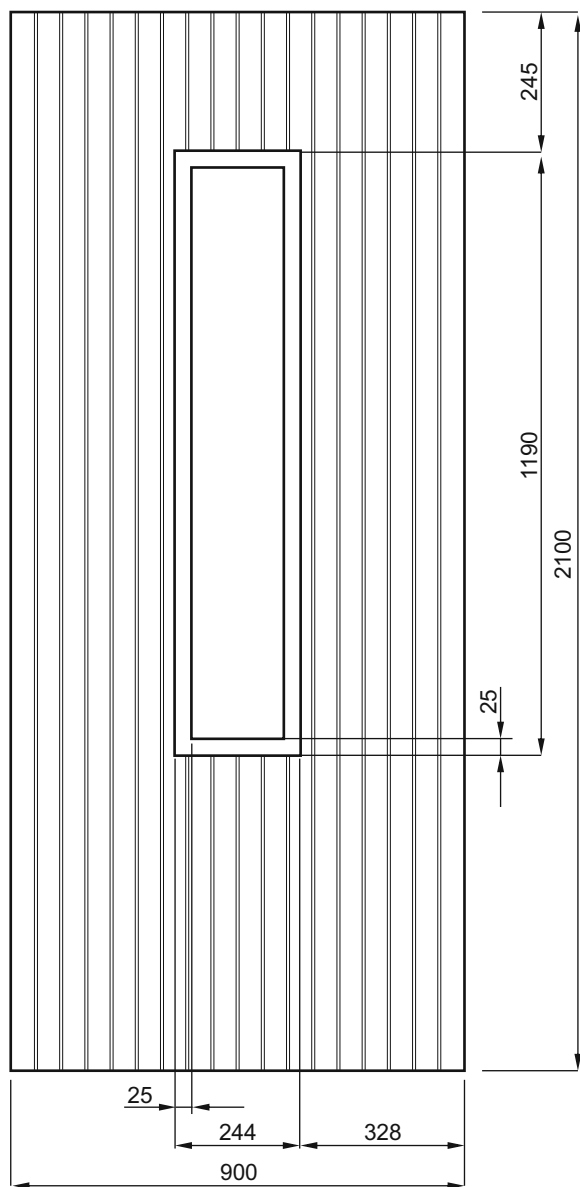

601 x 1700mm
 Minimální rozměry
 Min. size
 Min. Ausmass
 Dimension minimales

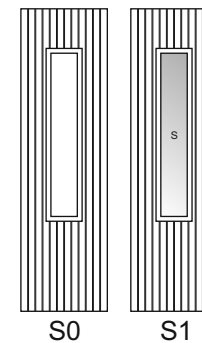
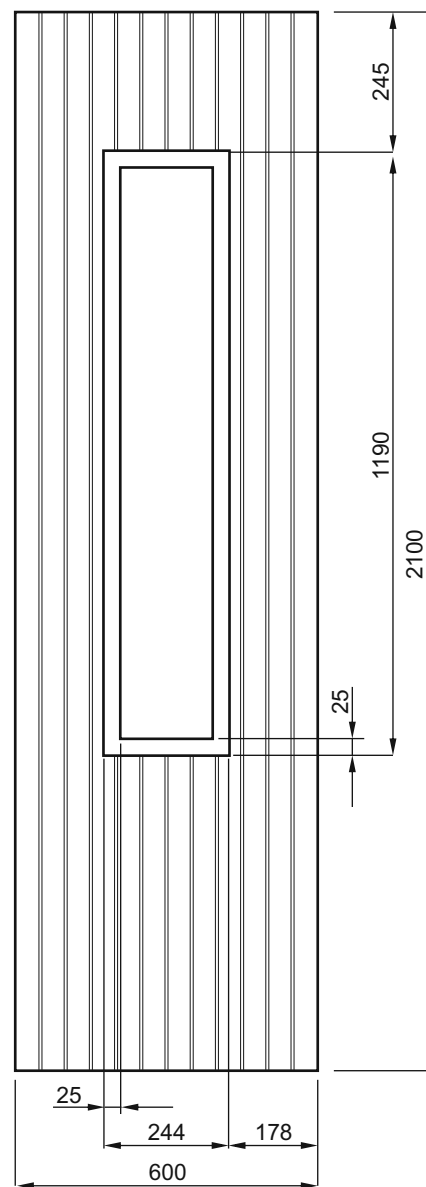

350 x 1700mm
 Minimální rozměry
 Min. size
 Min. Ausmass
 Dimension minimales

Klabava

Klabava 1/2

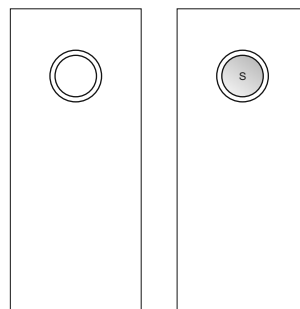
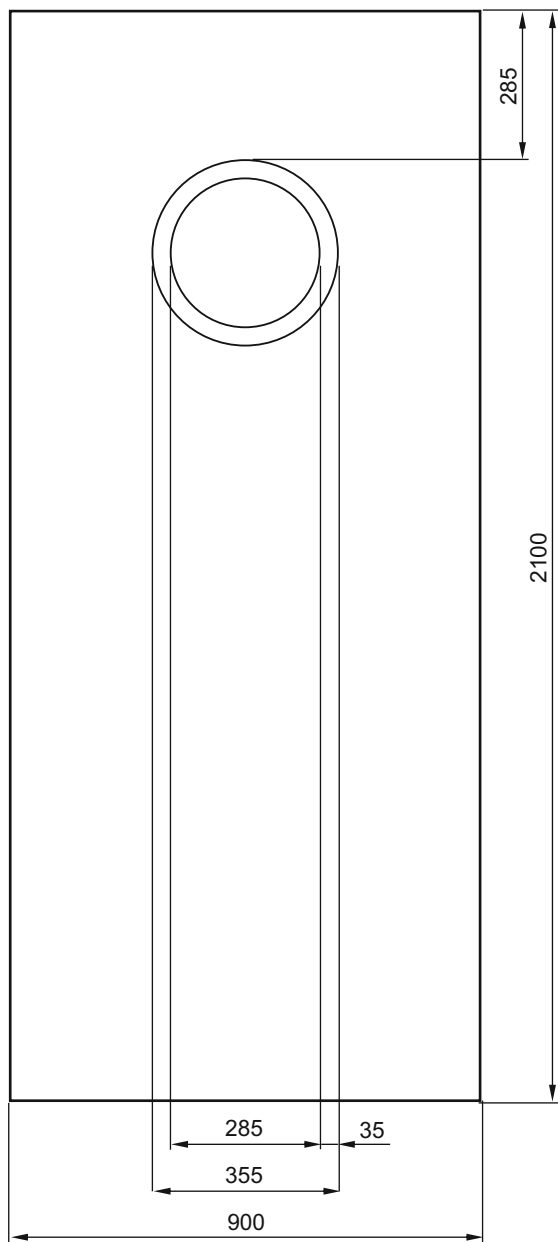

S0

S1

480 x 1600mm

Minimální rozměry

Min. size

Min. Ausmass

Dimension minimales

Korál

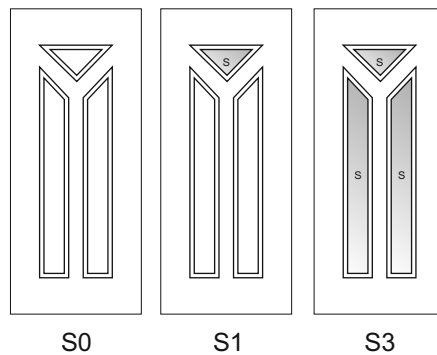
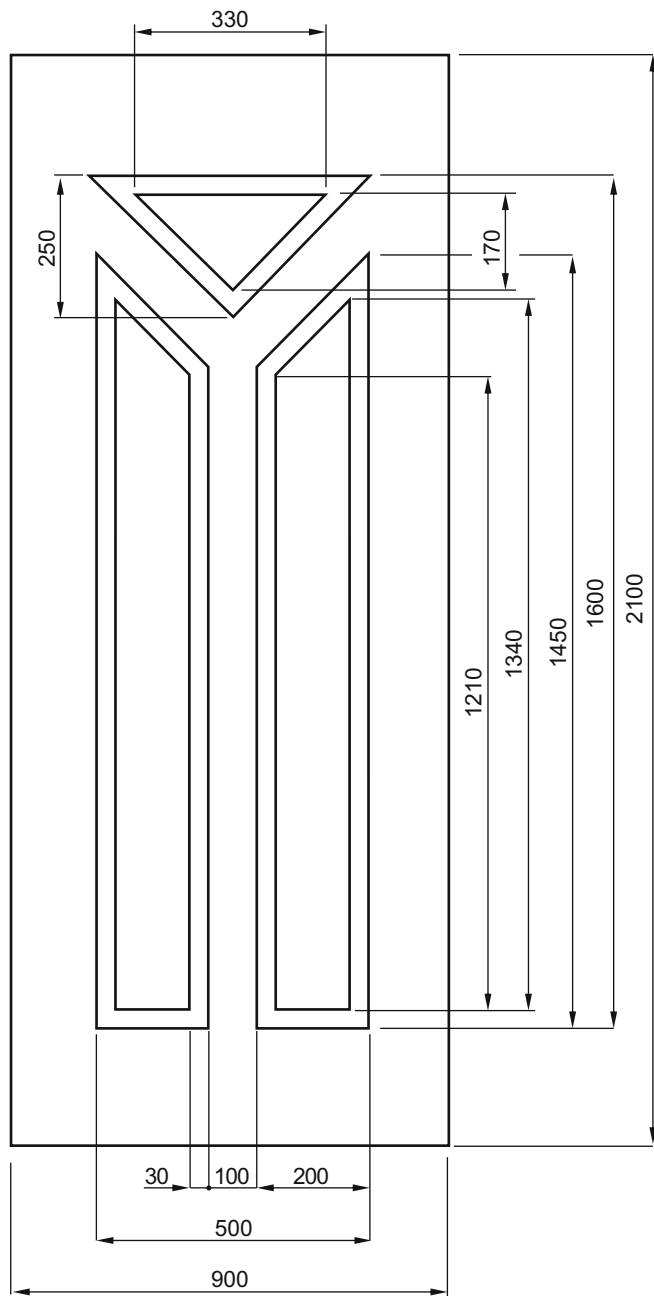

580 x 1680mm
 Minimální rozměry
 Min. size
 Min. Ausmass
 Dimension minimales

Krystal

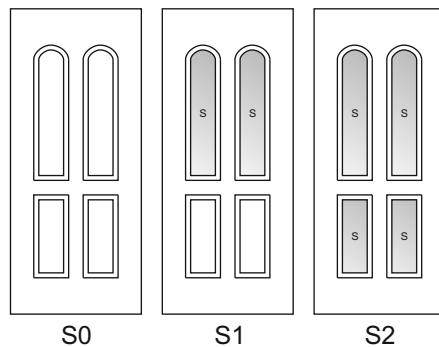
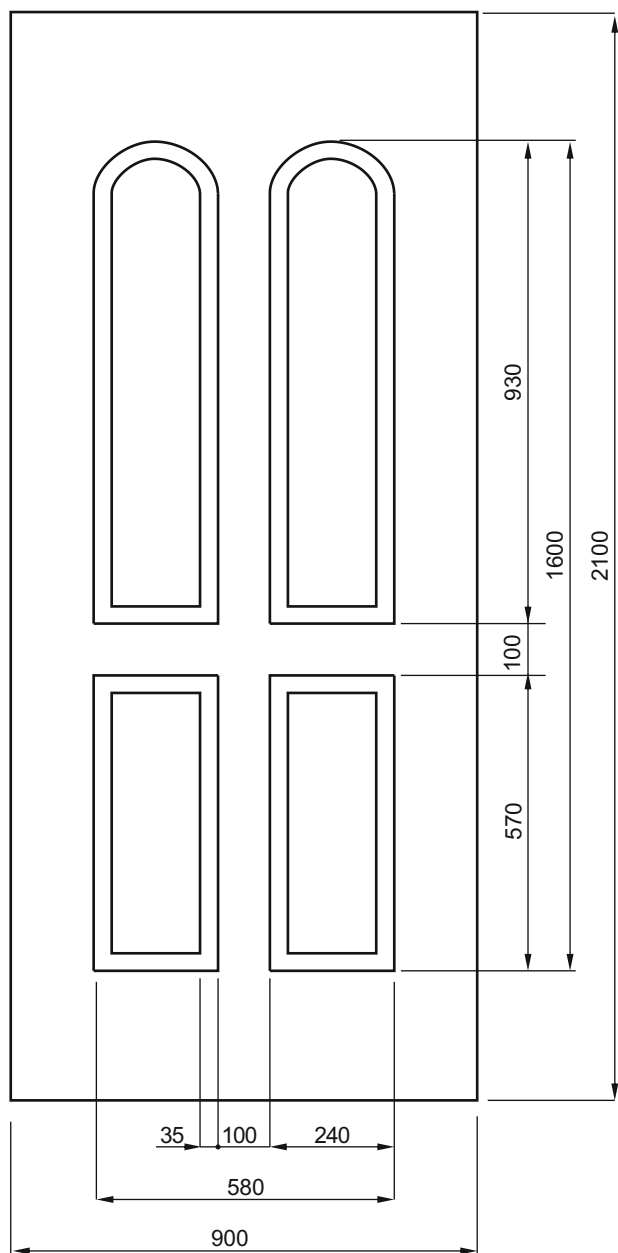

660 x 1680mm
 Minimální rozměry
 Min. size
 Min. Ausmass
 Dimension minimales

Labe

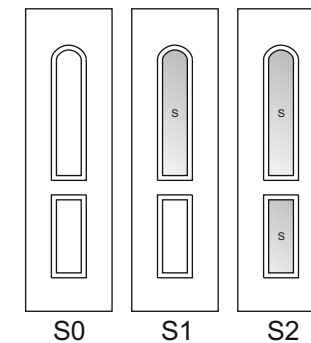
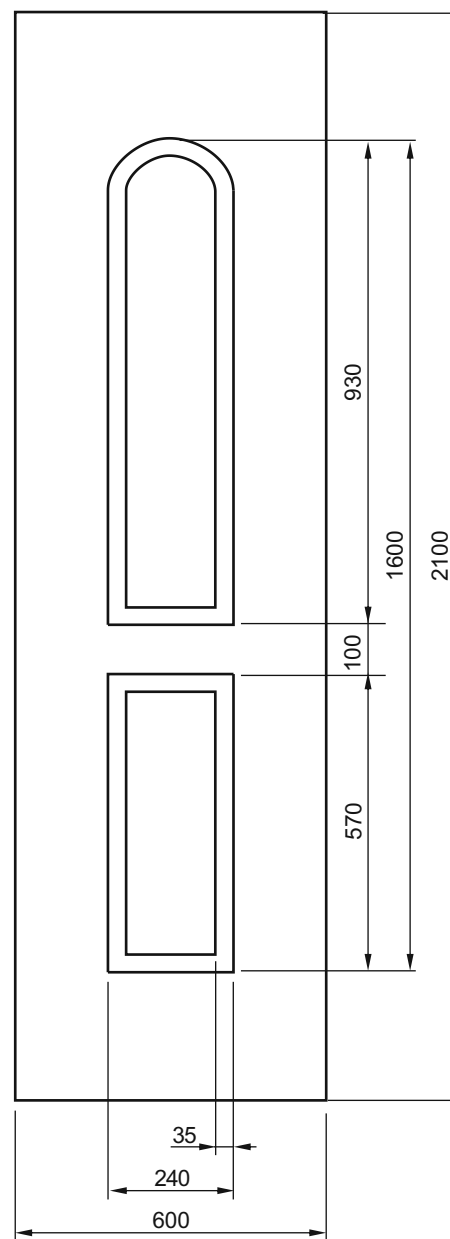

320 x 1680mm
 Minimální rozměry
 Min. size
 Min. Ausmass
 Dimension minimales

Labe 1/2

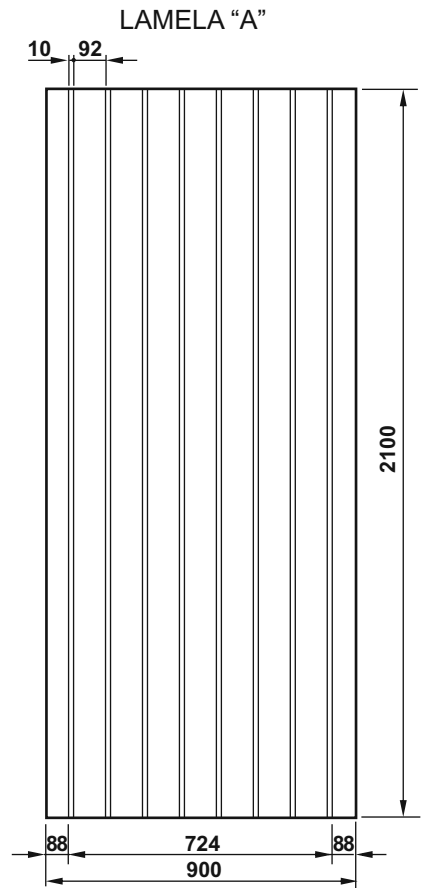

hloubka prolisu = 2 mm
offset depth
Tiefe der Versetzung (Einpresstiefe)
profondeur l' moulage

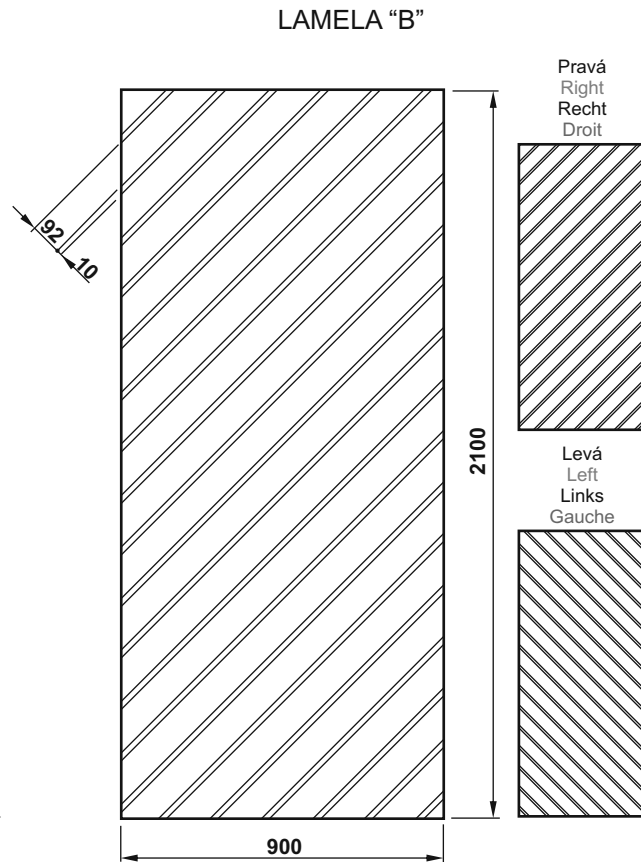

hloubka prolisu = 2 mm
offset depth
Tiefe der Versetzung (Einpresstiefe)
profondeur l' moulage

úhel sklonu: 45°
inclination angle
Neigungswinkel
angle d' inclinaison

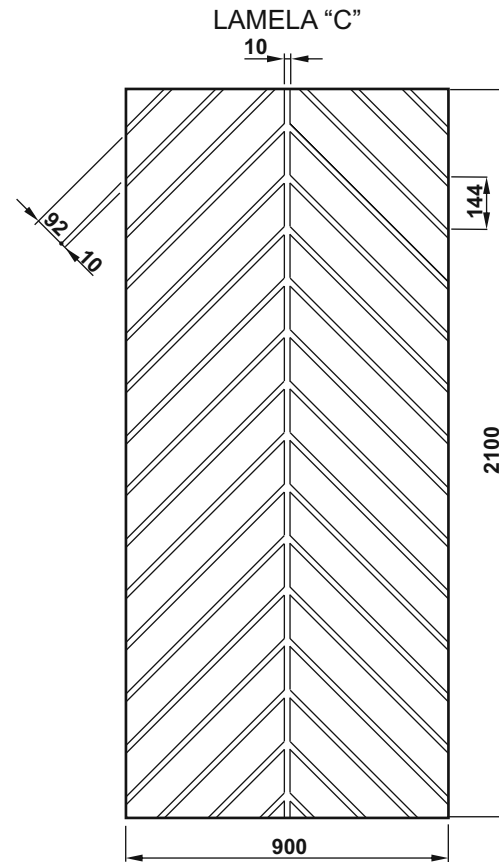

hloubka prolisu = 2 mm
offset depth
Tiefe der Versetzung (Einpresstiefe)
profondeur l' moulage

úhel sklonu: 45°
inclination angle
Neigungswinkel
angle d' inclinaison

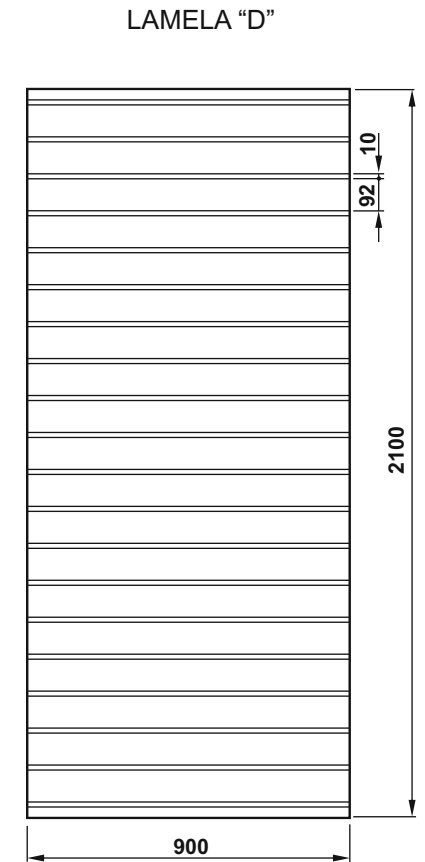

hloubka prolisu = 2 mm
offset depth
Tiefe der Versetzung (Einpresstiefe)
profondeur l' moulage

Lamely

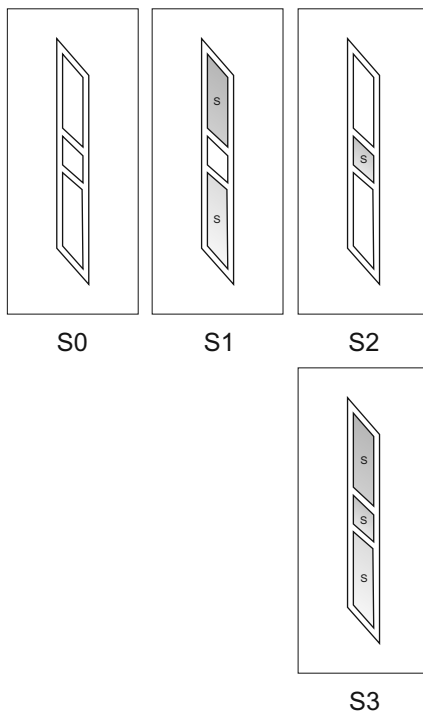
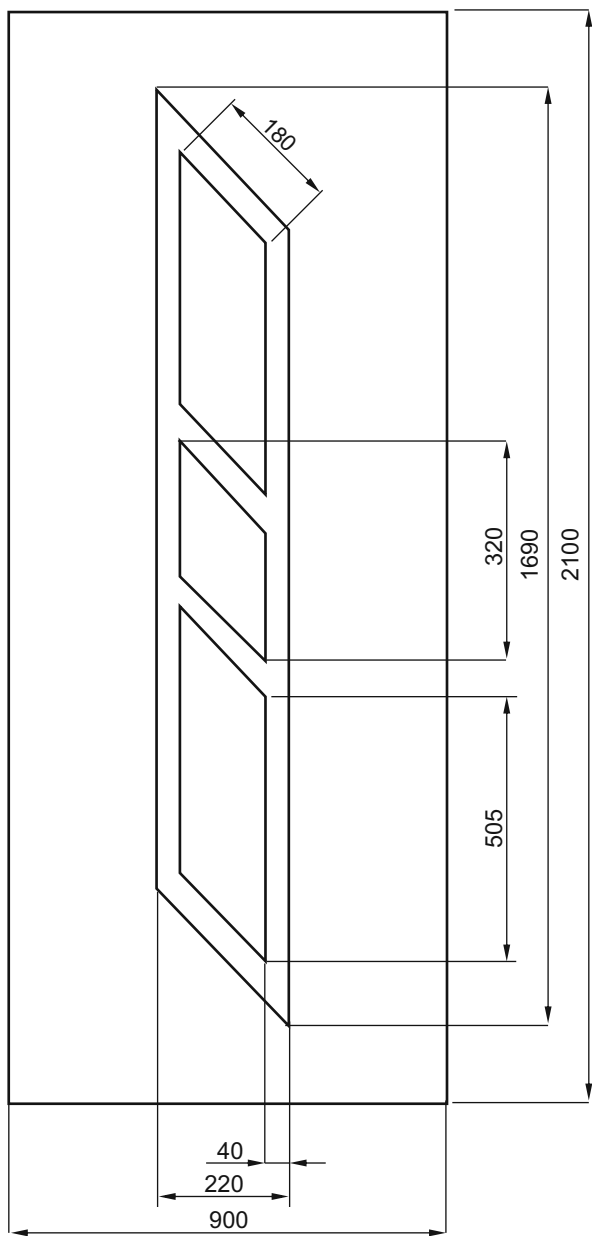

601 x 1770mm
 Minimální rozměry
 Min. size
 Min. Ausmass
 Dimension minimales

Litavka

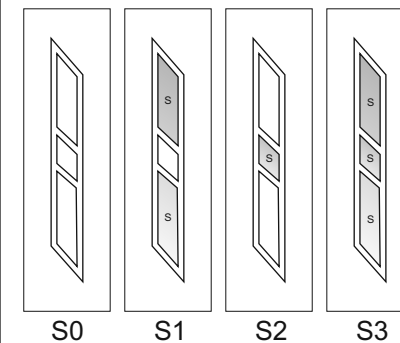
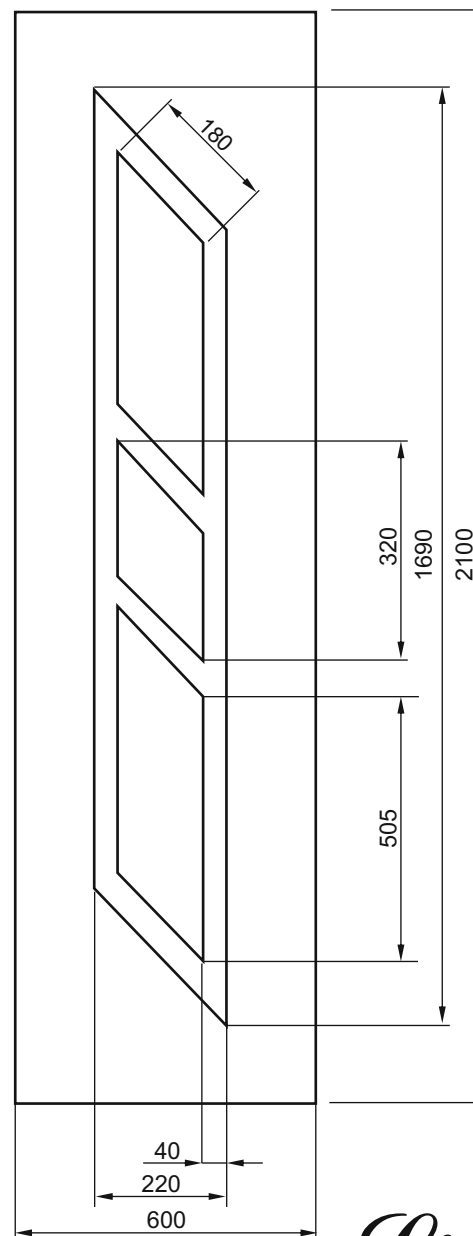

300 x 1770mm
 Minimální rozměry
 Min. size
 Min. Ausmass
 Dimension minimales

Litavka 1/2

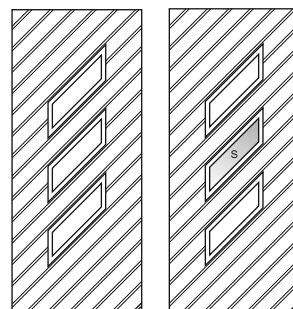
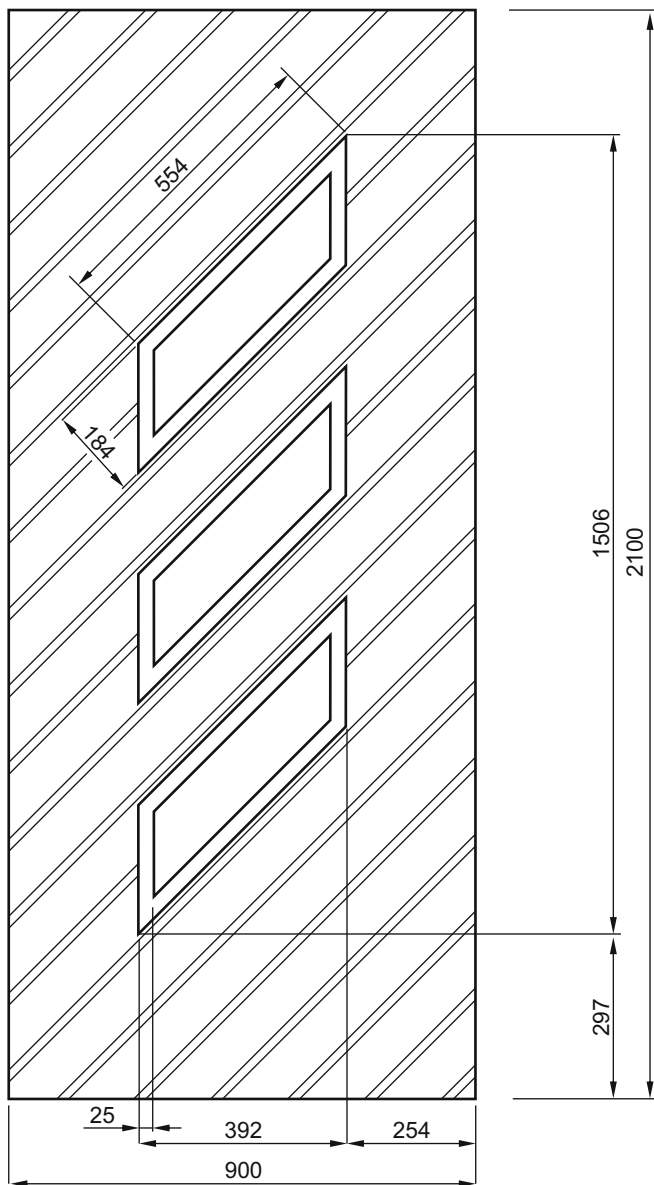

S0

S1

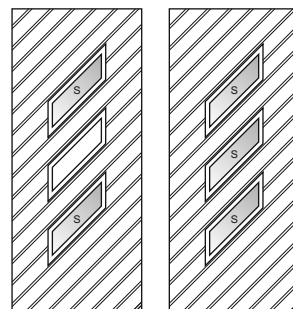

S2

S3

601 x 1606mm
 Minimální rozměry
 Min. size
 Min. Ausmass
 Dimension minimales

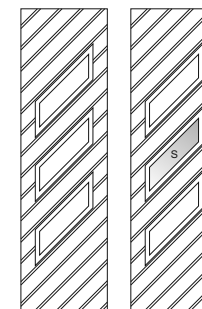
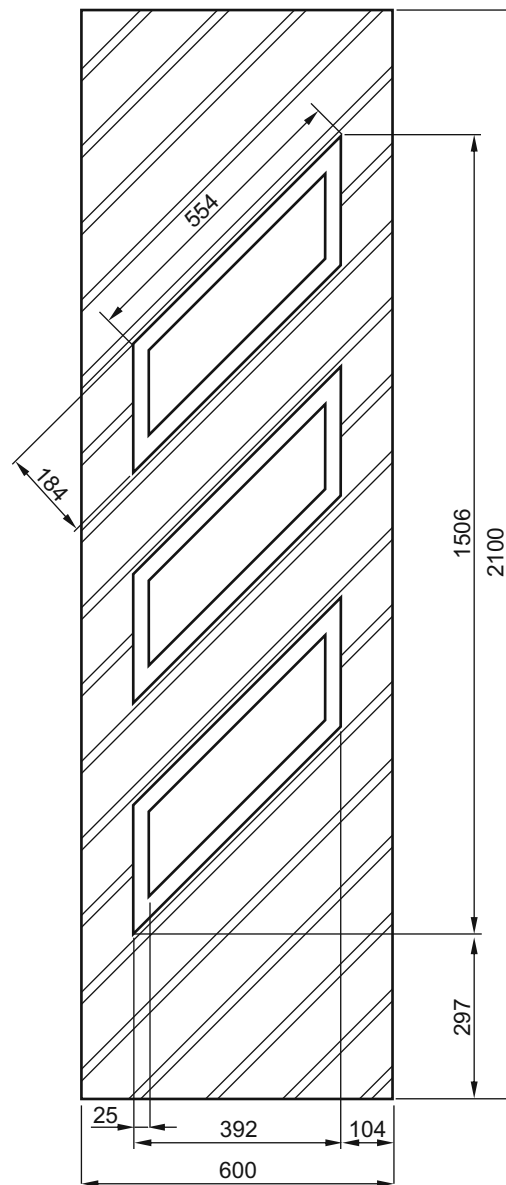

S0

S1

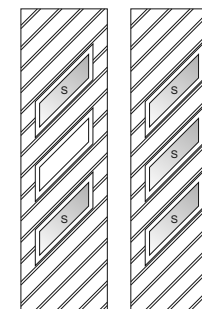

S2

S3

500 x 1606mm
 Minimální rozměry
 Min. size
 Min. Ausmass
 Dimension minimales

Lomnice

Lomnice 1/2

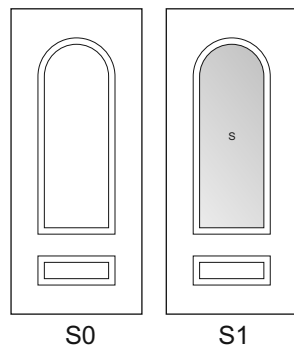
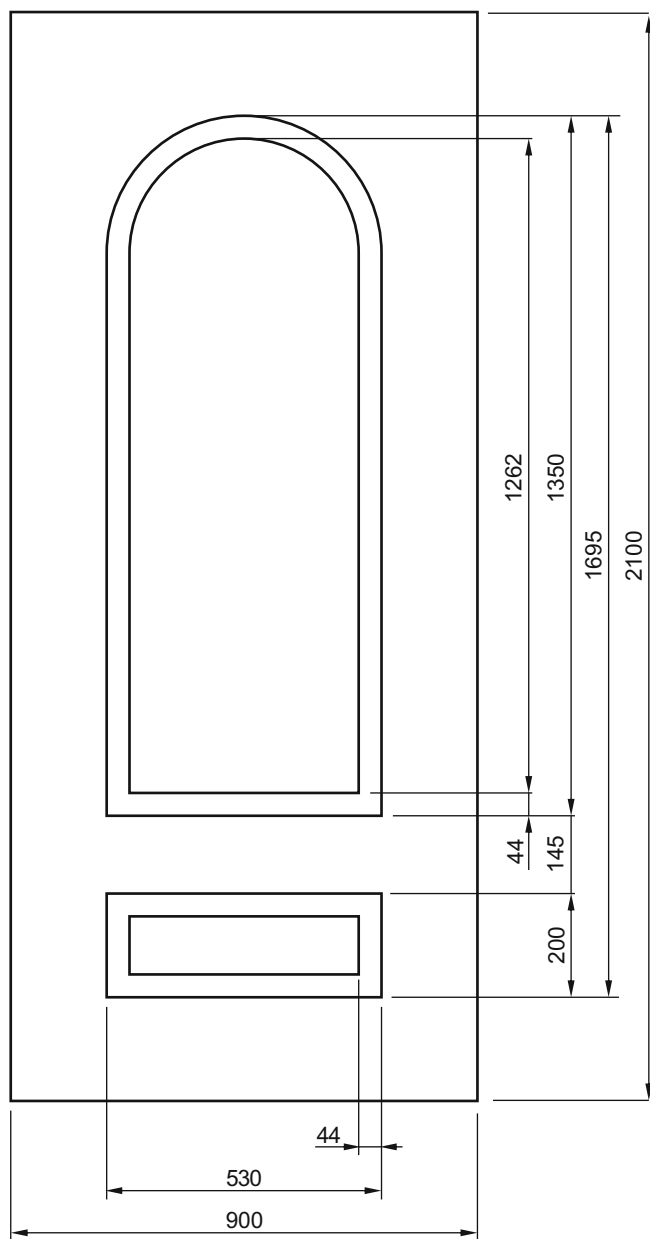

660 x 1680mm
 Minimální rozměry
 Min. size
 Min. Ausmass
 Dimension minimales

Lužnice

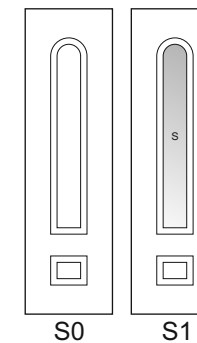
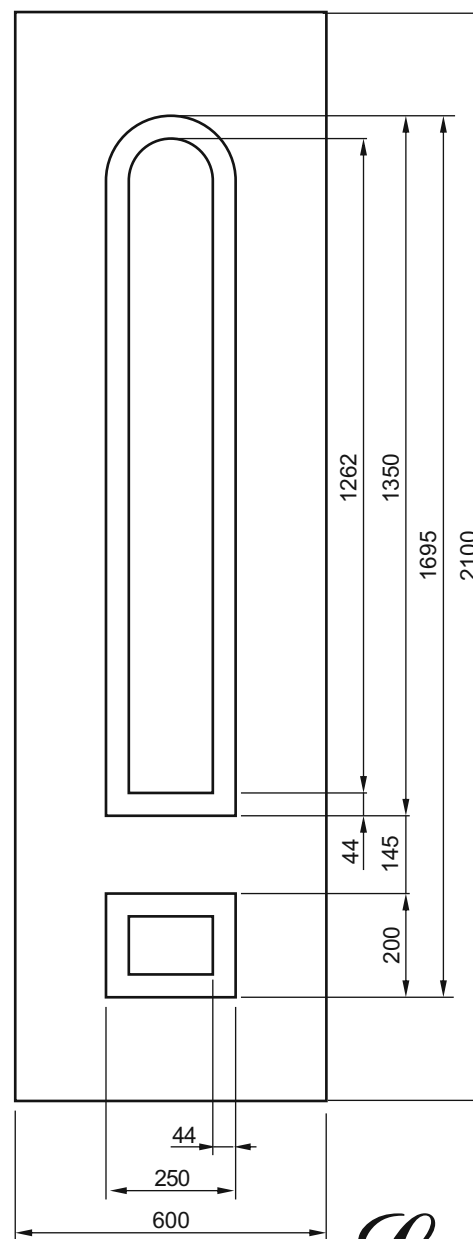

320 x 1680mm
 Minimální rozměry
 Min. size
 Min. Ausmass
 Dimension minimales

Lužnice 1/2

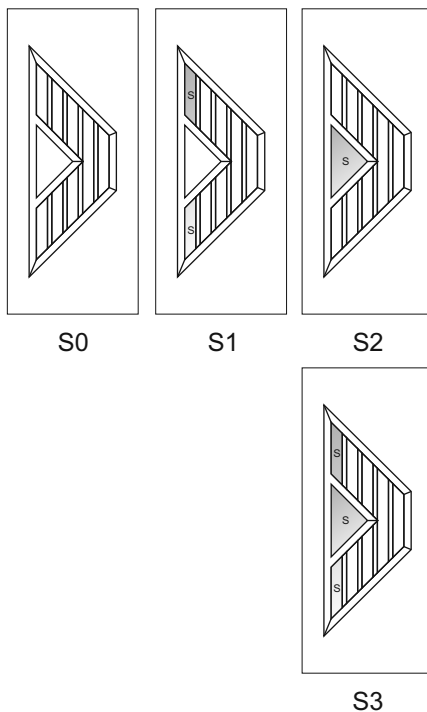
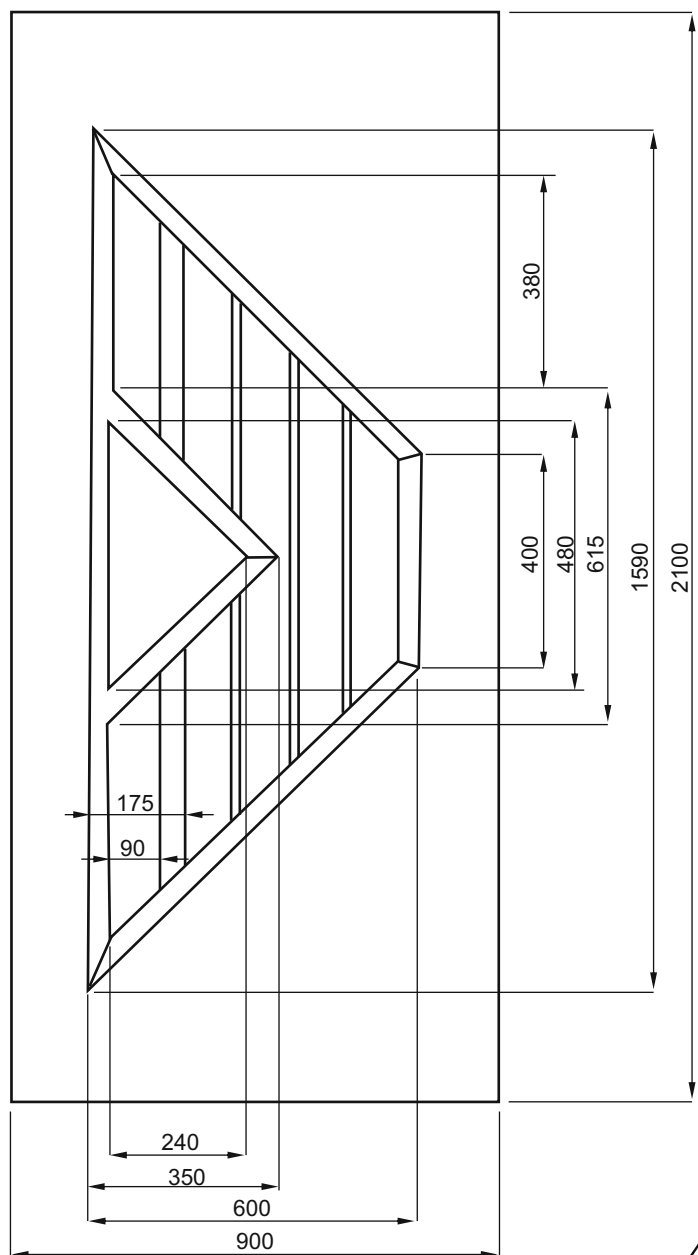

720 x 1720mm
 Minimální rozměry
 Min. size
 Min. Ausmass
 Dimension minimales

Malachyt

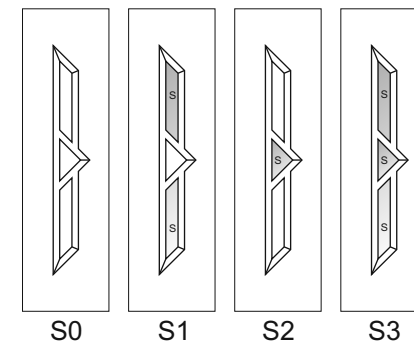
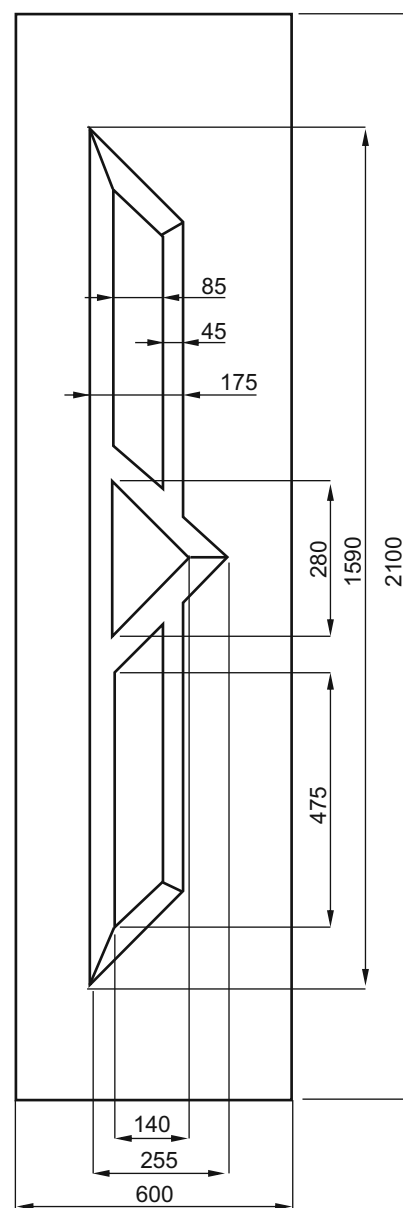

380 x 1720mm
 Minimální rozměry
 Min. size
 Min. Ausmass
 Dimension minimales

Malachyt 1/2

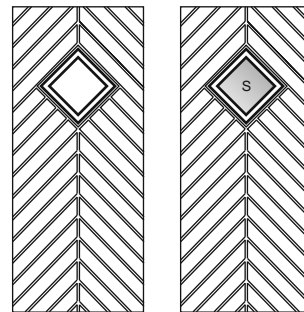
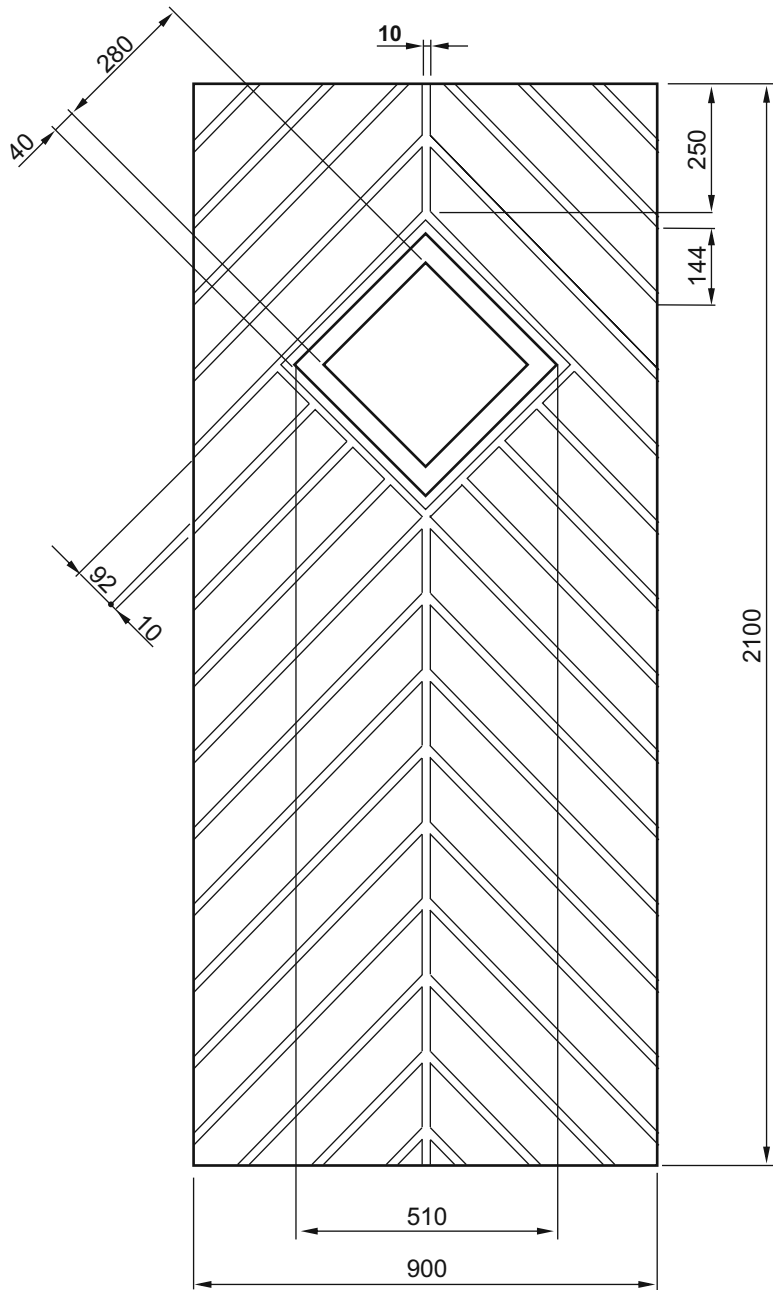

S0

S1

600 x 1700mm
 Minimální rozměry
 Min. size
 Min. Ausmass
 Dimension minimales

Metuje

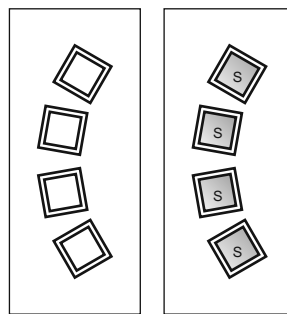
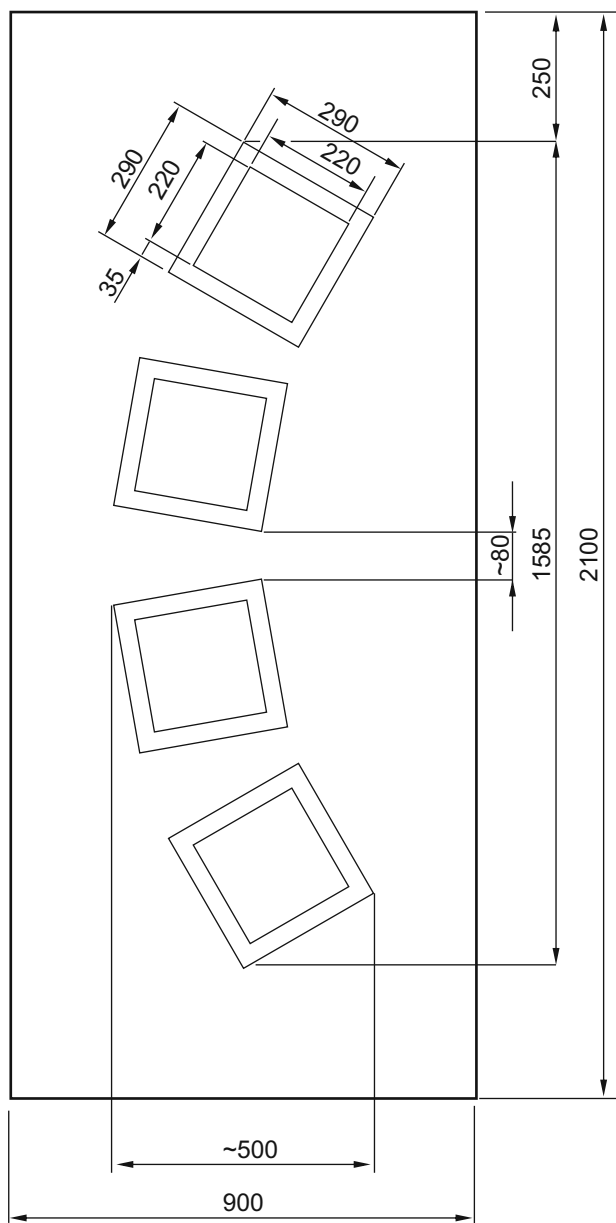

S0

S4

580 x 1680mm
 Minimální rozměry
 Min. size
 Min. Ausmass
 Dimension minimales

Morava

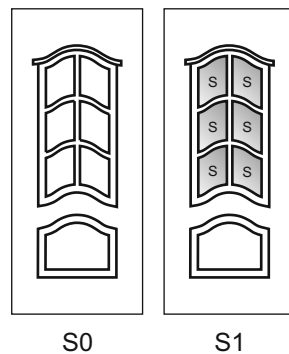
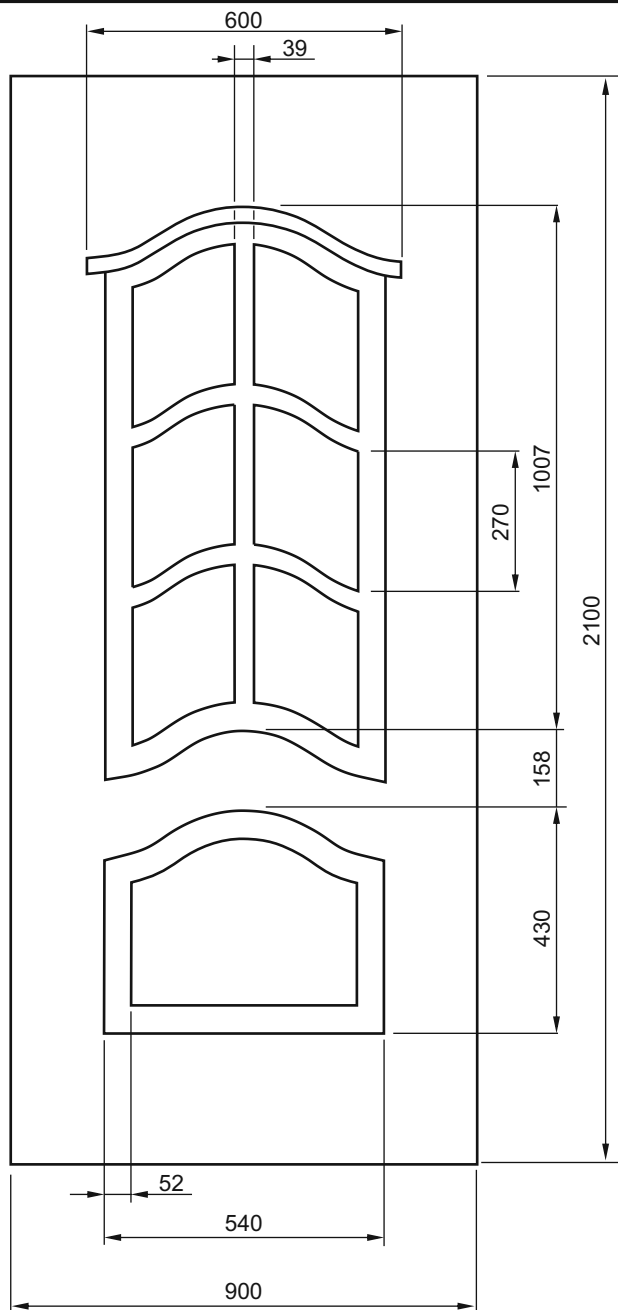

680 x 1680mm
 Minimální rozměry
 Min. size
 Min. Ausmass
 Dimension minimales

Nisa

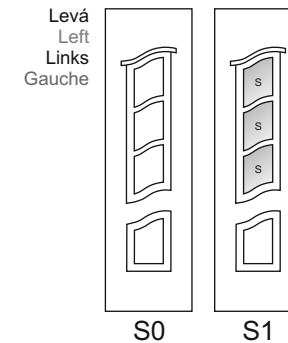
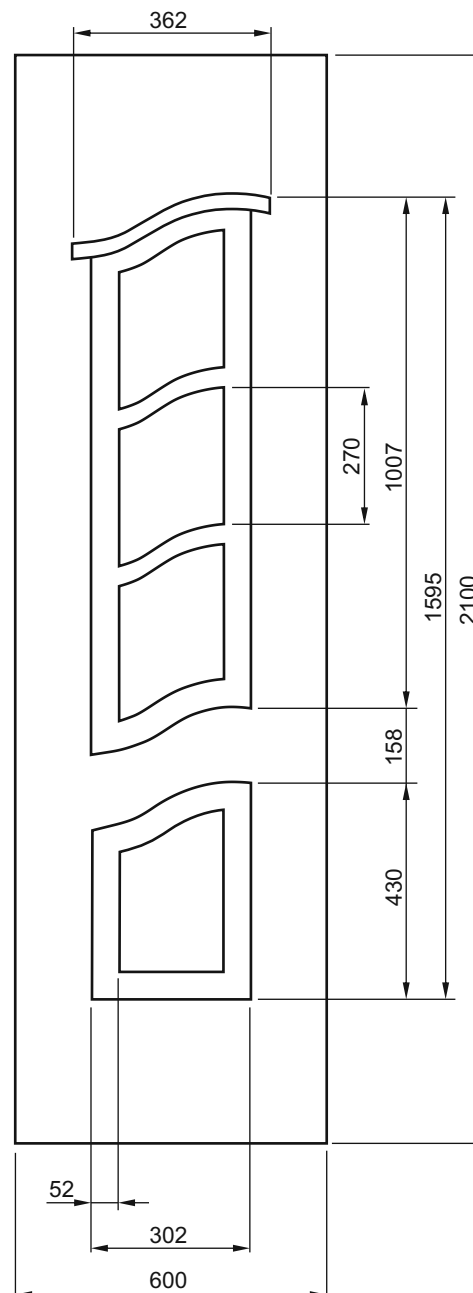

Pravá
Right
Recht
Droit

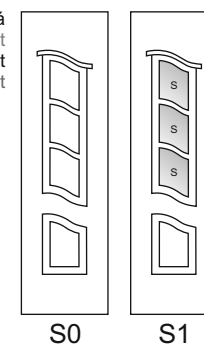

450 x 1680mm
 Minimální rozměry
 Min. size
 Min. Ausmass
 Dimension minimales

Nisa 1/2

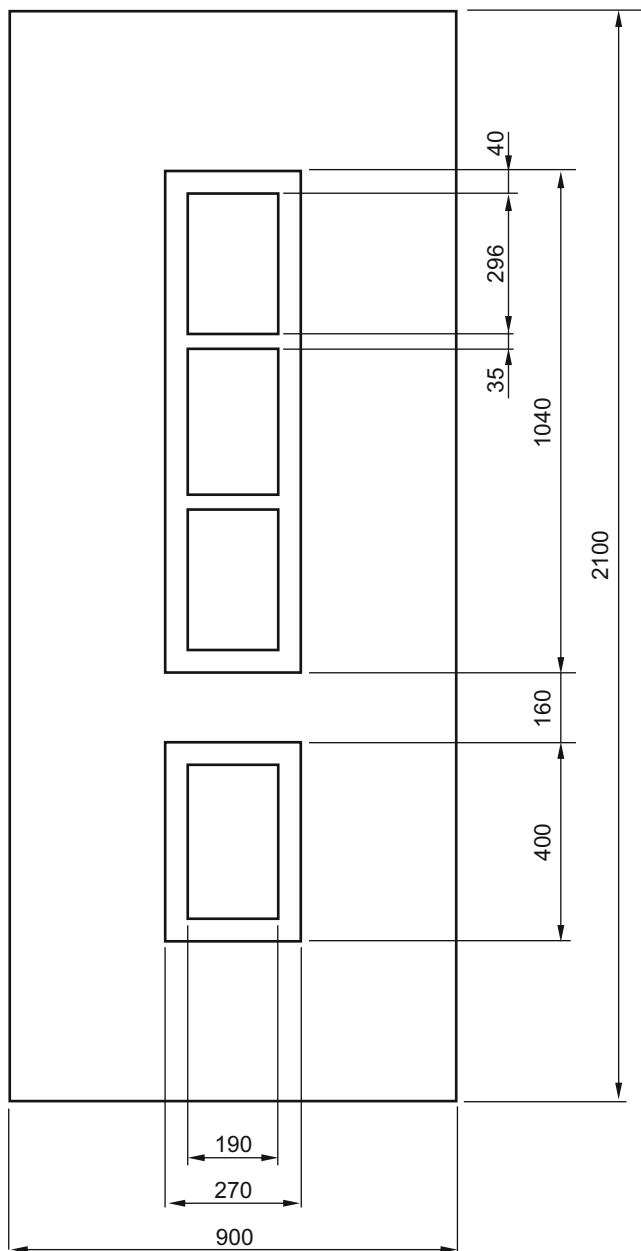

601 x 1680mm
 Minimální rozměry
 Min. size
 Min. Ausmass
 Dimension minimales

Odra

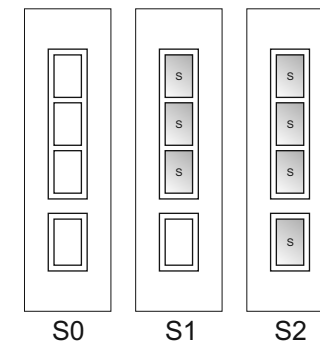
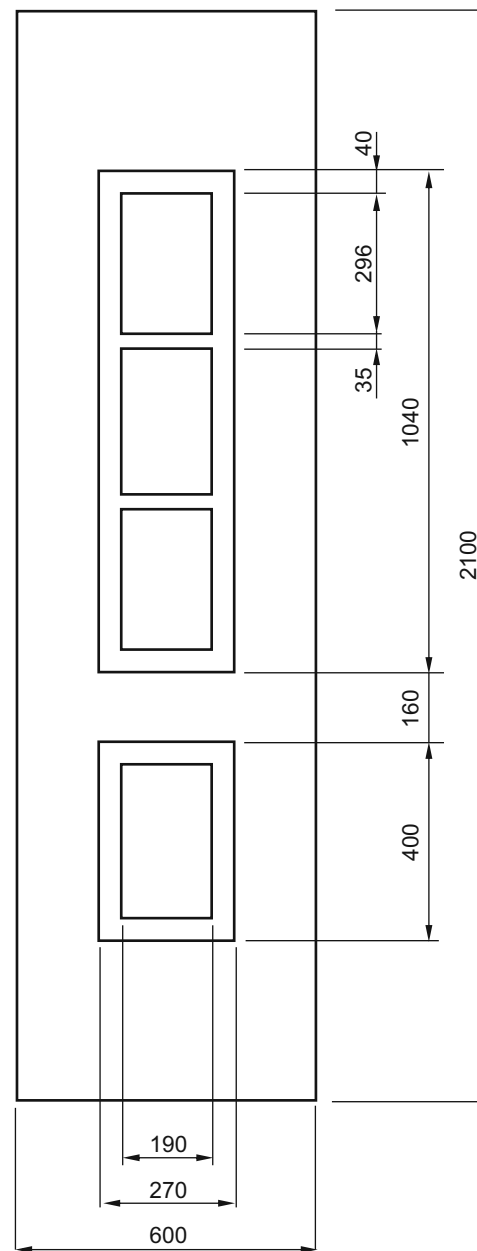

350 x 1680mm
 Minimální rozměry
 Min. size
 Min. Ausmass
 Dimension minimales

Odra 1/2

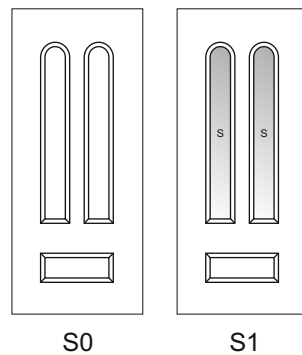
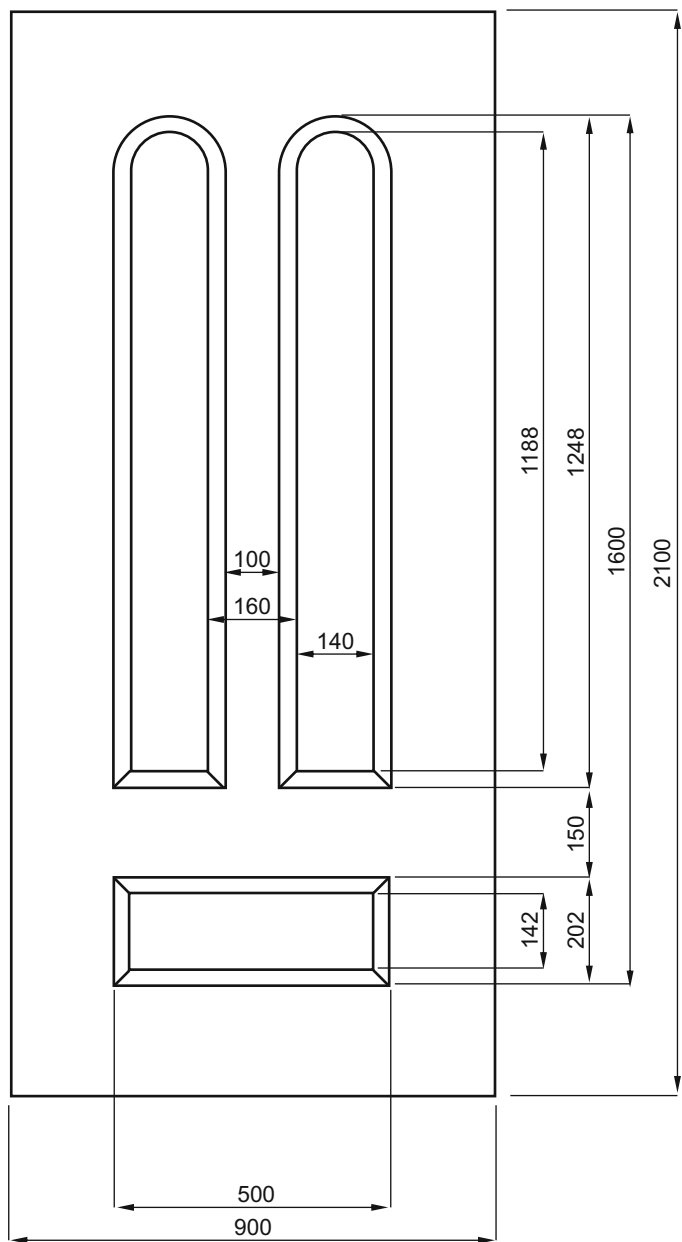

620 x 1710mm
 Minimální rozměry
 Min. size
 Min. Ausmass
 Dimension minimales

Olivin

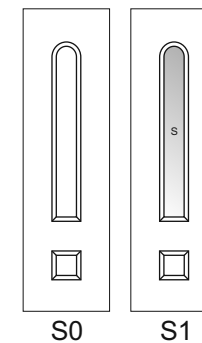
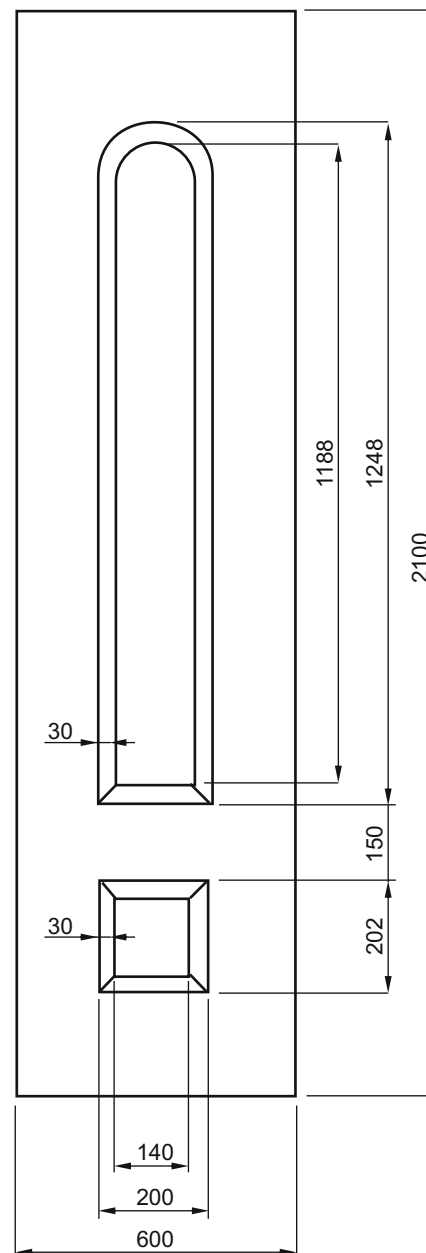

320 x 1710mm
 Minimální rozměry
 Min. size
 Min. Ausmass
 Dimension minimales

Olivin 1/2

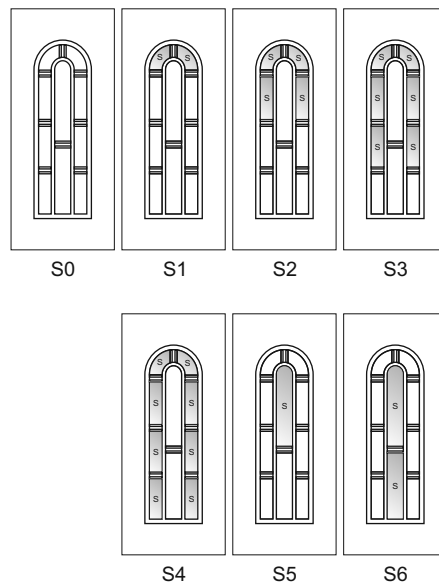
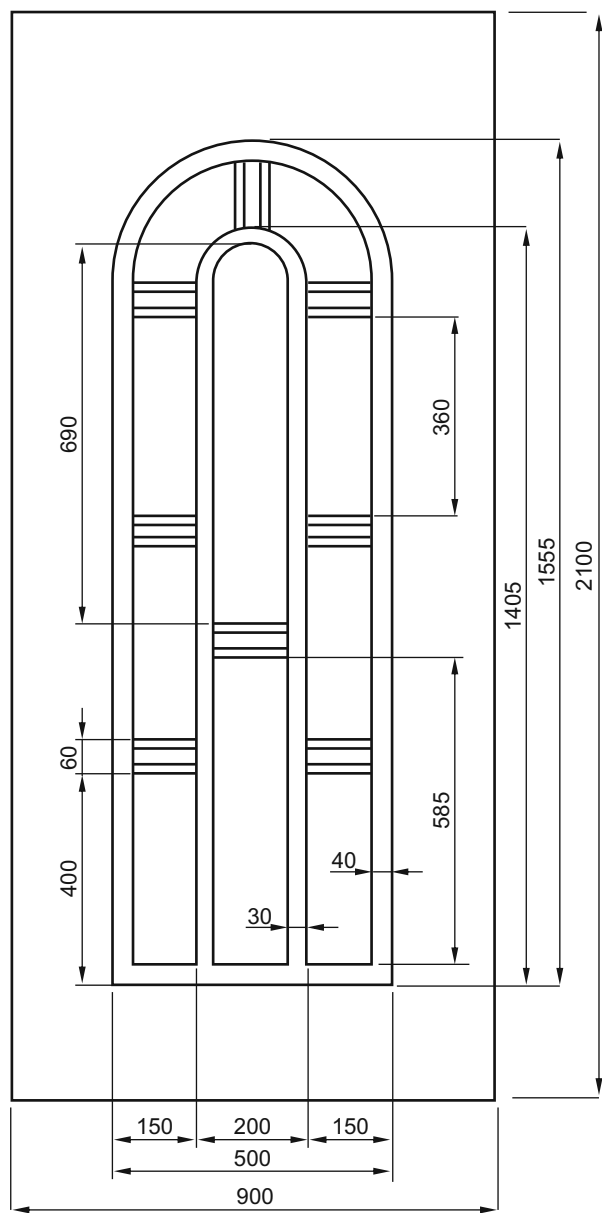

620 x 1680mm
 Minimální rozměry
 Min. size
 Min. Ausmass
 Dimension minimales

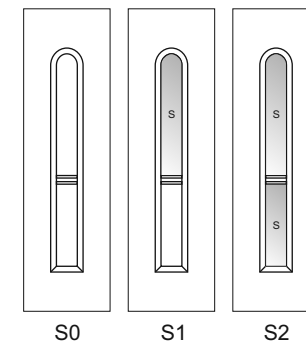
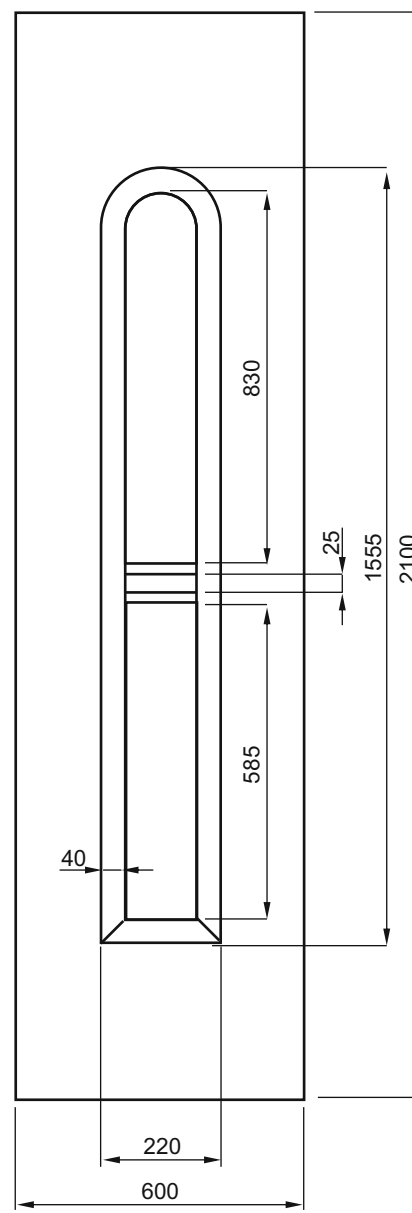

350 x 1680mm
 Minimální rozměry
 Min. size
 Min. Ausmass
 Dimension minimales

Onyx

Onyx 1/2

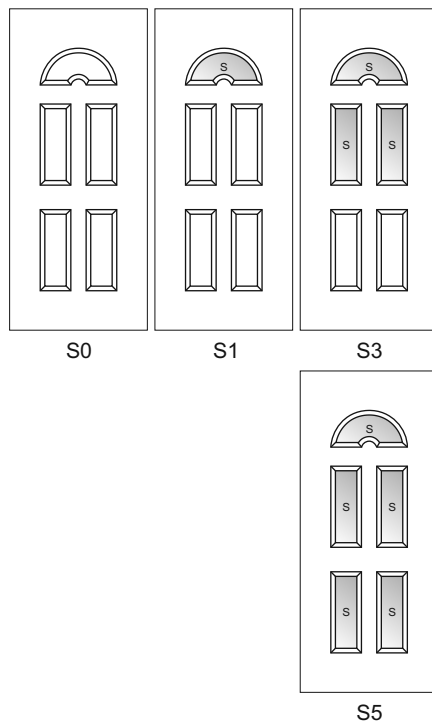
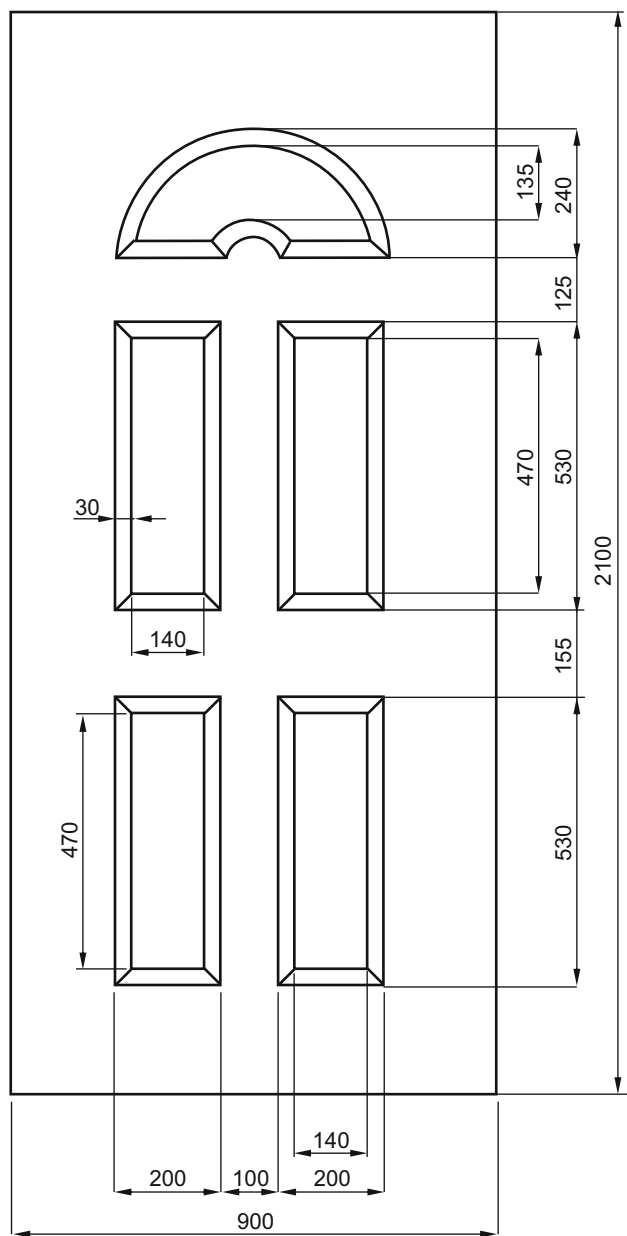

620 x 1710mm
 Minimální rozměry
 Min. size
 Min. Ausmass
 Dimension minimales

Opál

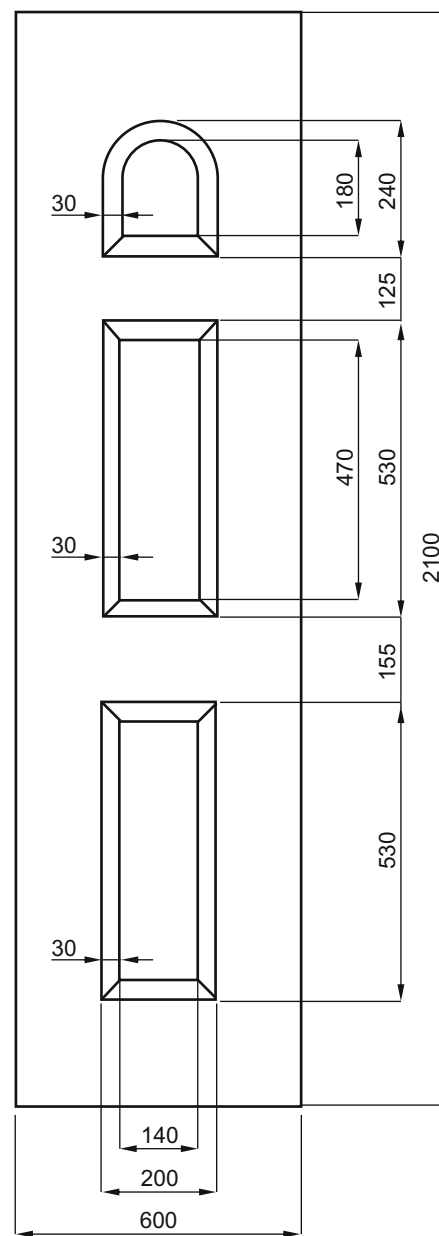

330 x 1710mm
 Minimální rozměry
 Min. size
 Min. Ausmass
 Dimension minimales

Opál 1/2

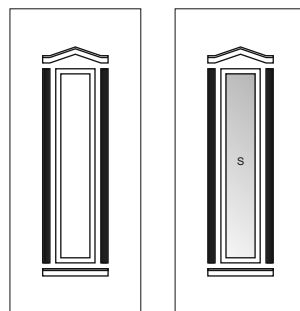
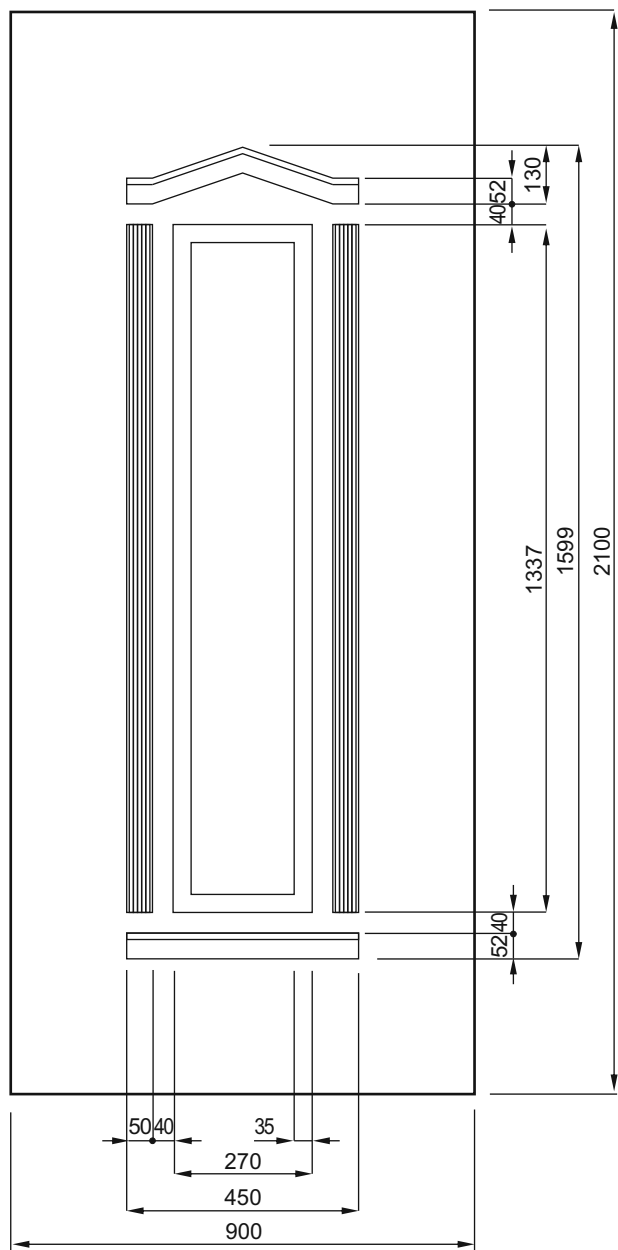

S0

S1

550 x 1700mm

Minimální rozměry

Min. size

Min. Ausmass

Dimension minimales

Orlice

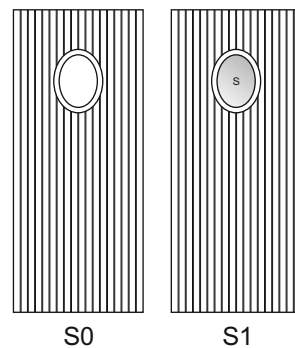
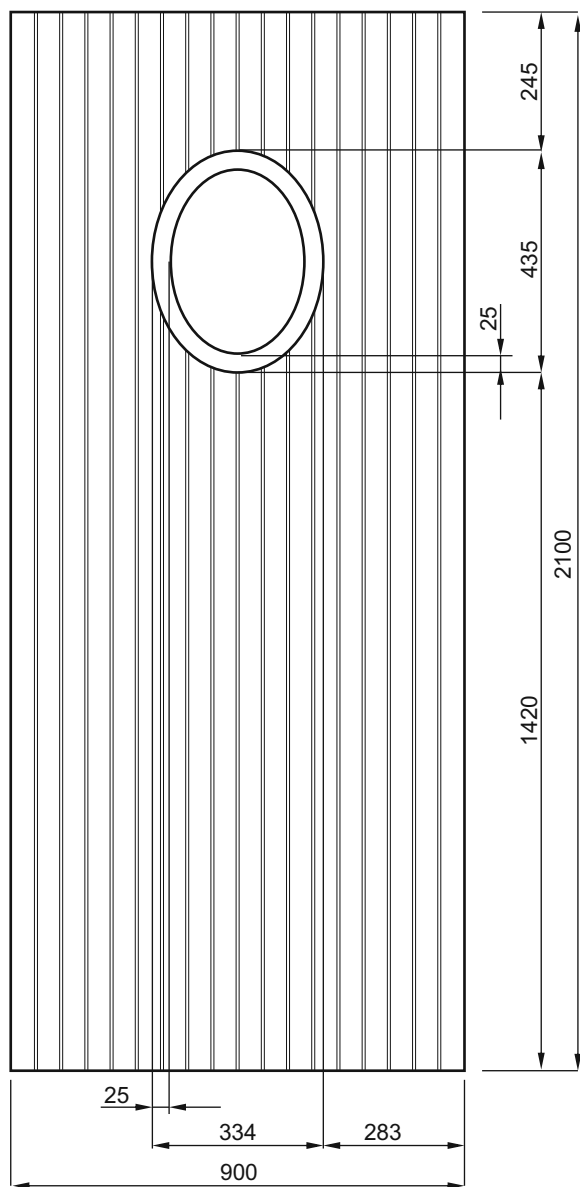

601 x 1600mm
 Minimální rozměry
 Min. size
 Min. Ausmass
 Dimension minimales

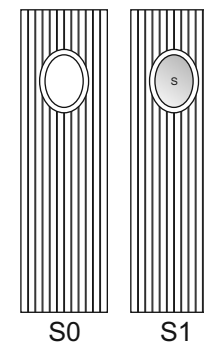
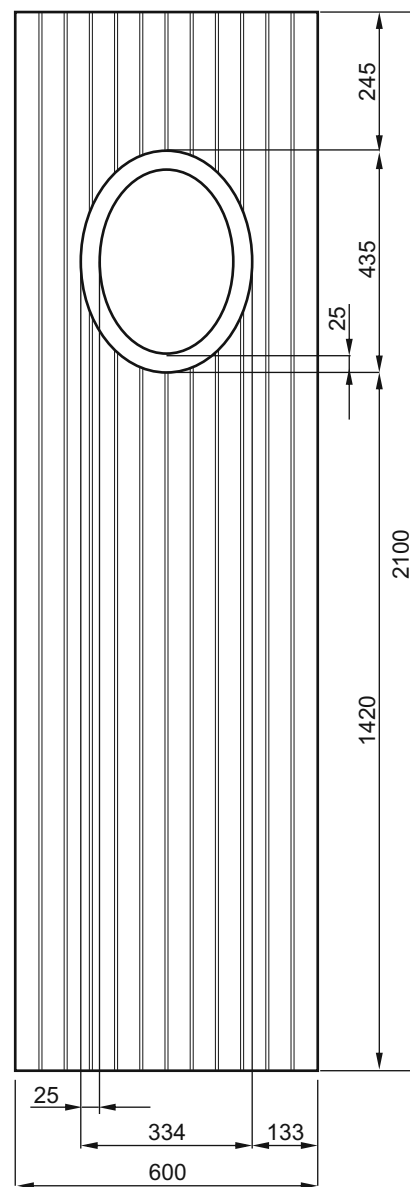

450 x 1600mm
 Minimální rozměry
 Min. size
 Min. Ausmass
 Dimension minimales

Otava

Otava 1/2

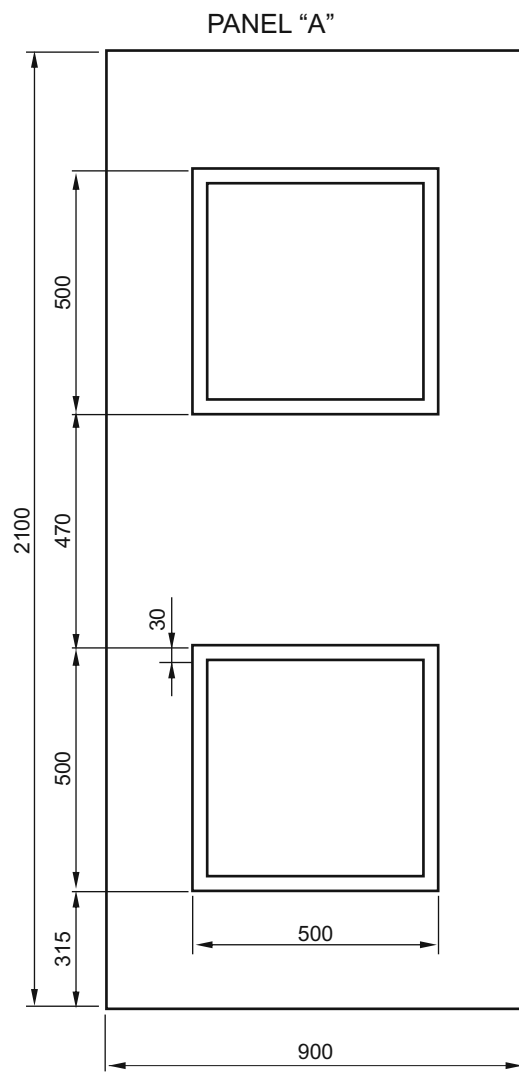

Minimální rozměry: 580 x 1550mm
 Min. size
 Min. Ausmass
 Dimension minimales

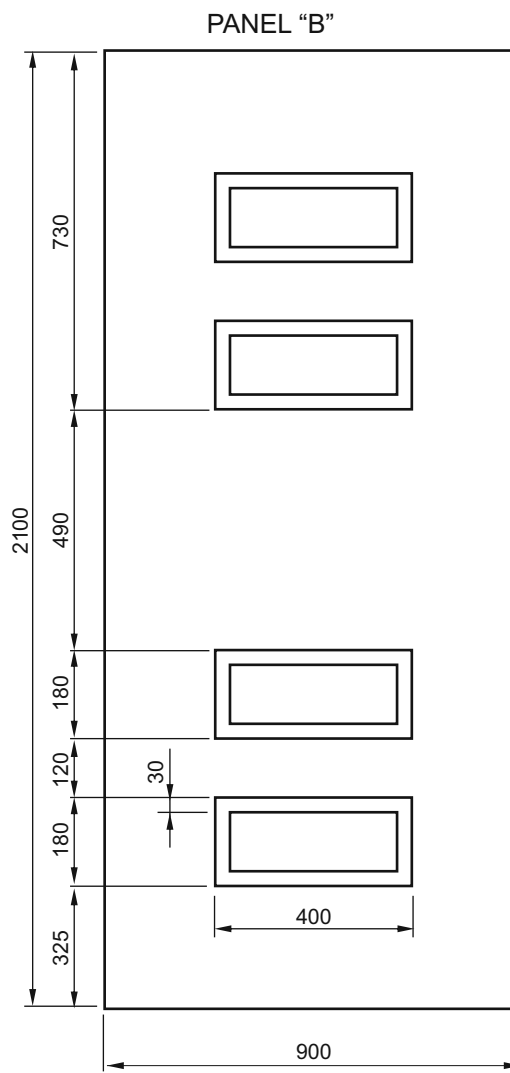

Minimální rozměry: 480 x 1530mm
 Min. size
 Min. Ausmass
 Dimension minimales

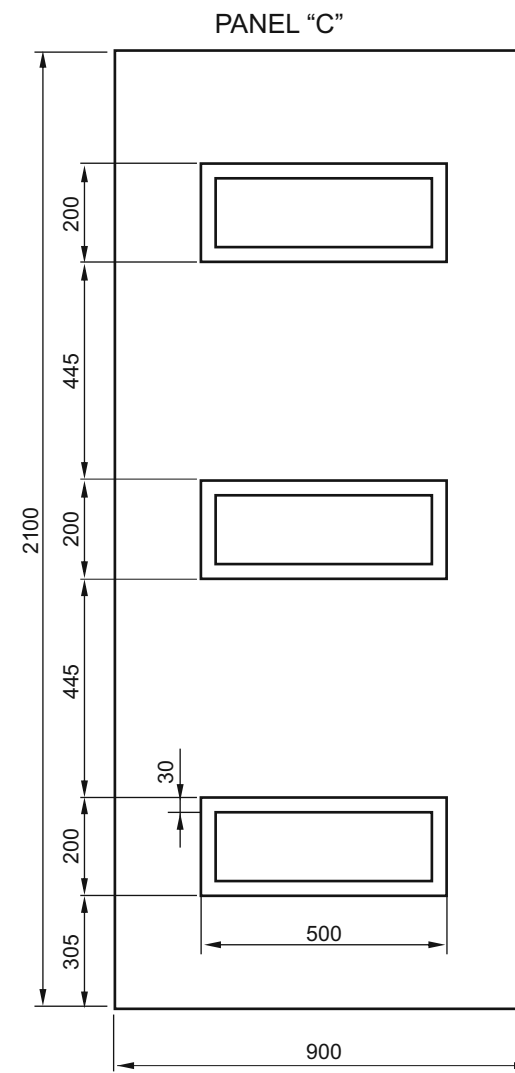

Minimální rozměry: 580 x 1570mm
 Min. size
 Min. Ausmass
 Dimension minimales

Panely

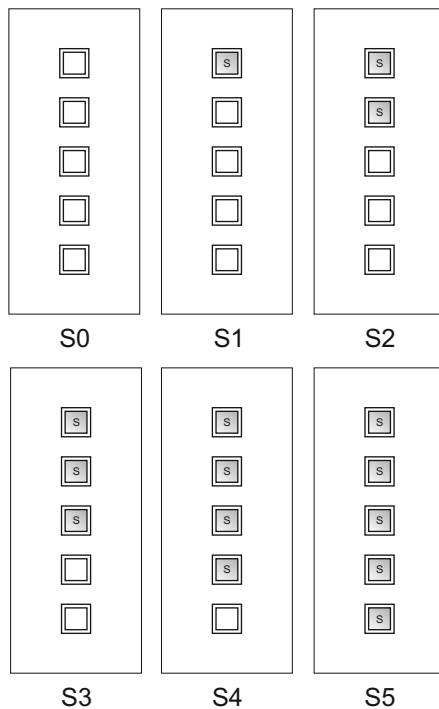
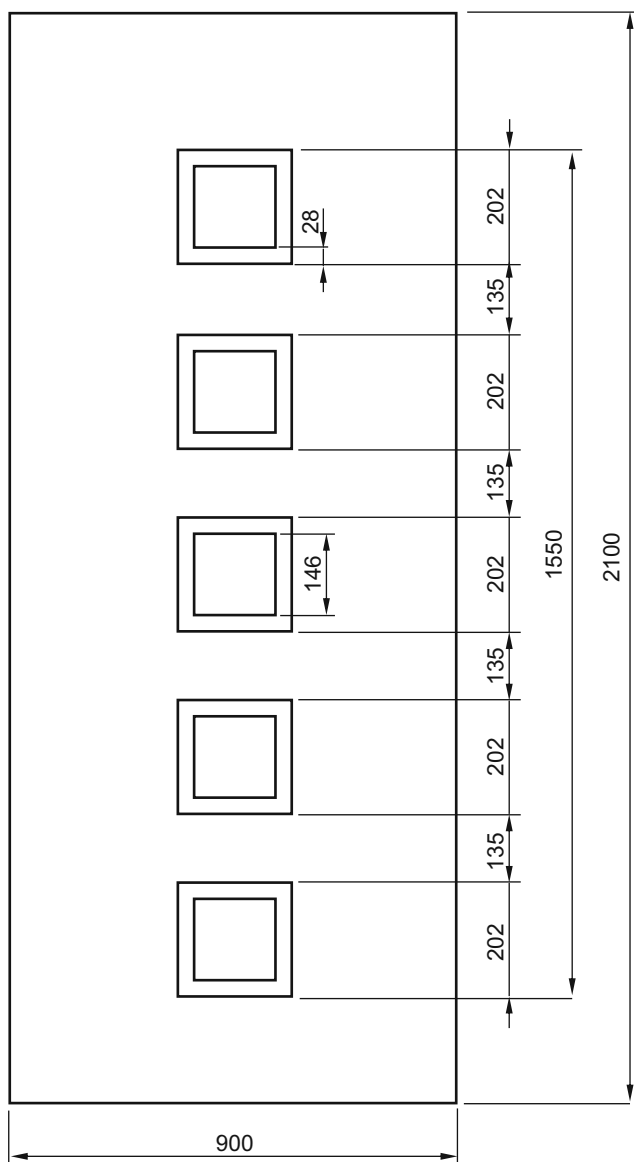

601 x 1630mm
 Minimální rozměry
 Min. size
 Min. Ausmass
 Dimension minimales

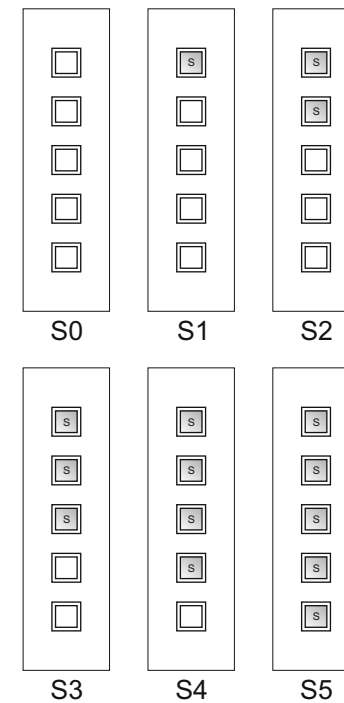
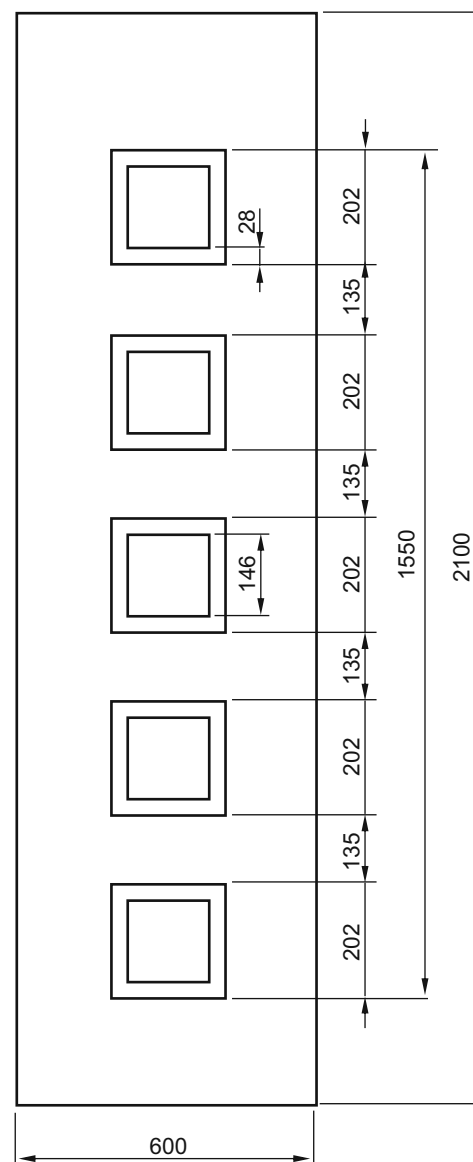

280 x 1630mm
 Minimální rozměry
 Min. size
 Min. Ausmass
 Dimension minimales

Radbuza

Radbuza 1/2

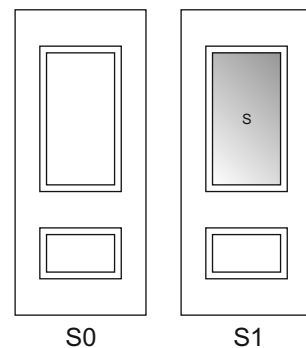
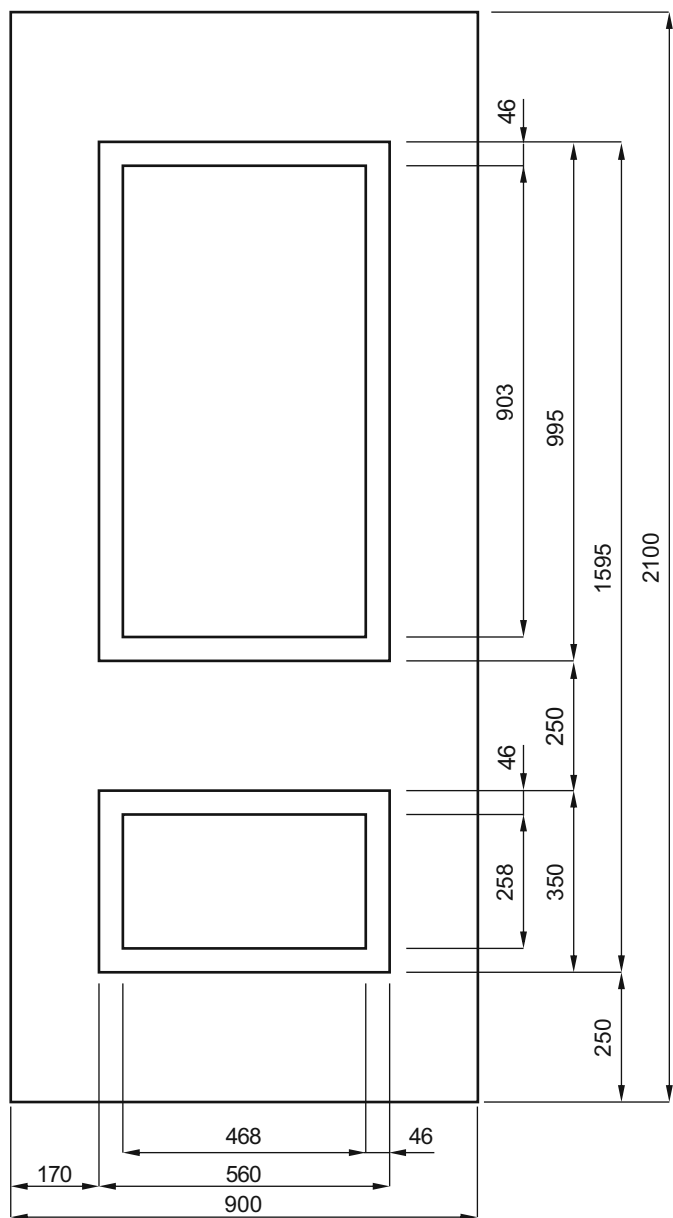

640 x 1680mm
 Minimální rozměry
 Min. size
 Min. Ausmass
 Dimension minimales

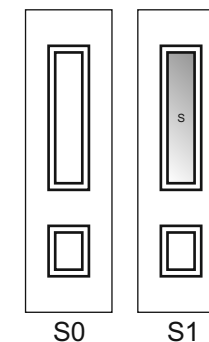
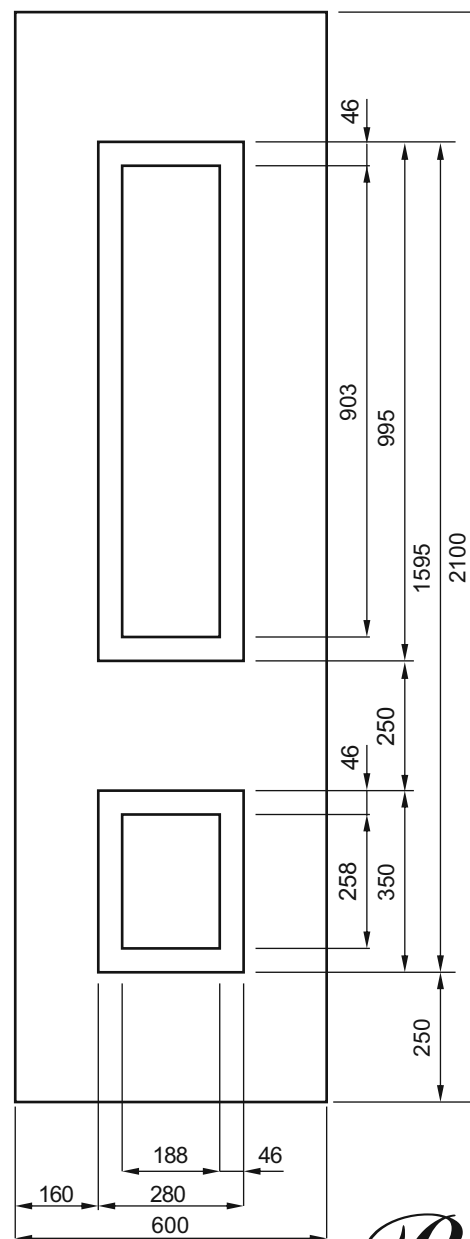

360 x 1680mm
 Minimální rozměry
 Min. size
 Min. Ausmass
 Dimension minimales

Rotava

Rotava 1/2

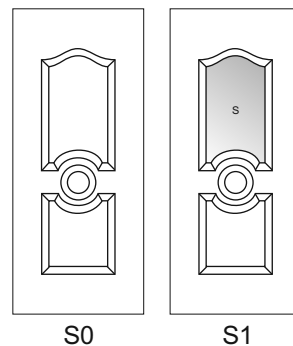
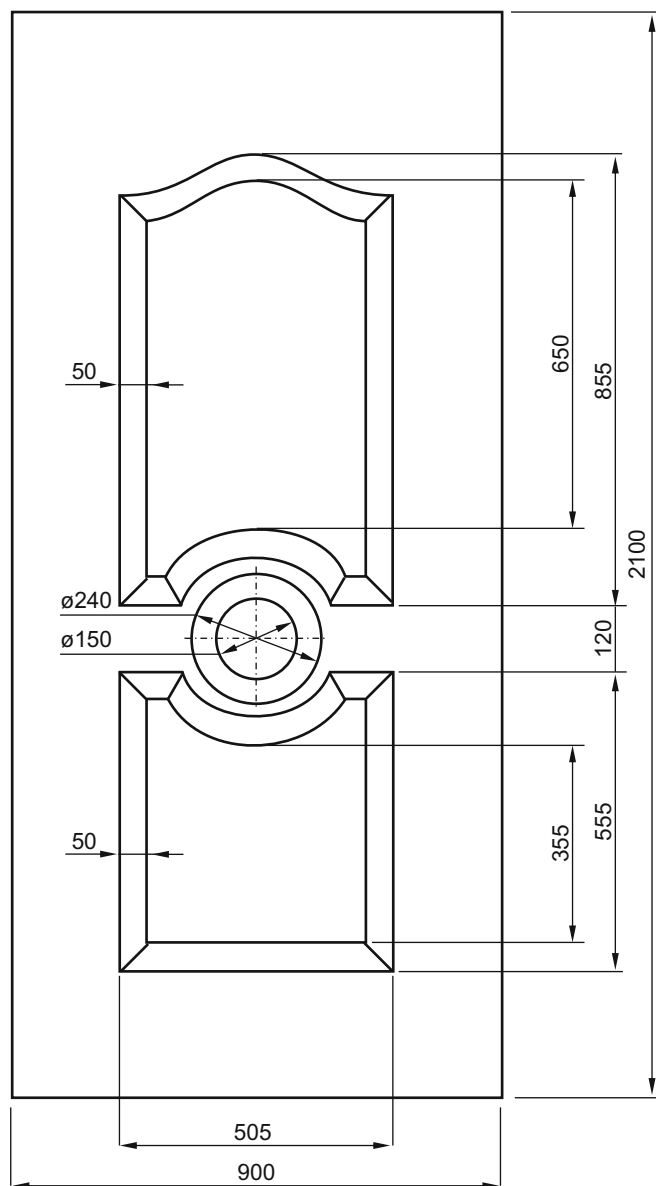

630 x 1650mm
 Minimální rozměry
 Min. size
 Min. Ausmass
 Dimension minimales

Pafír

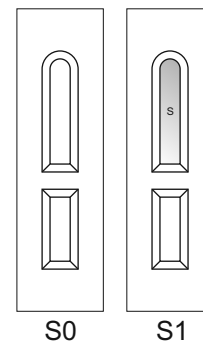
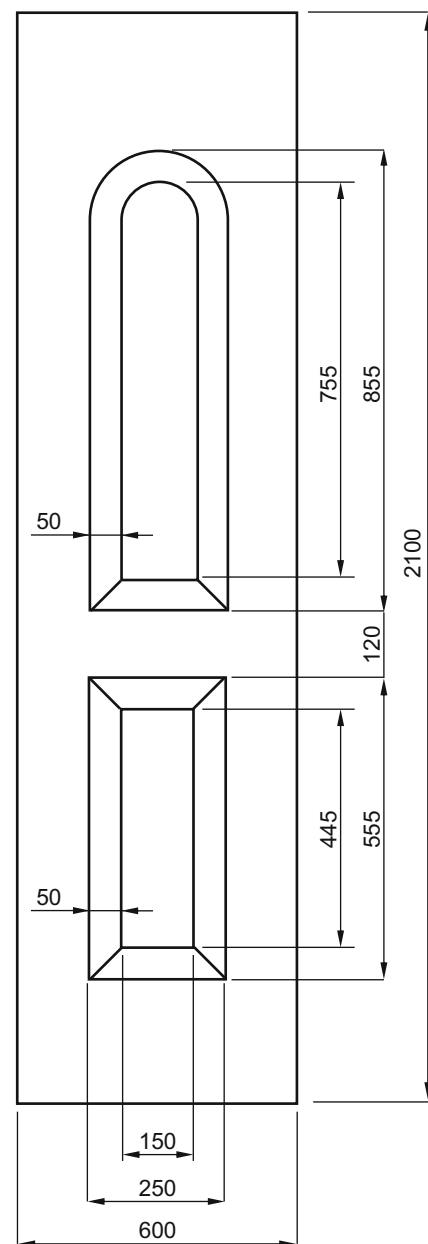

370 x 1650mm
 Minimální rozměry
 Min. size
 Min. Ausmass
 Dimension minimales

Pafír 1/2

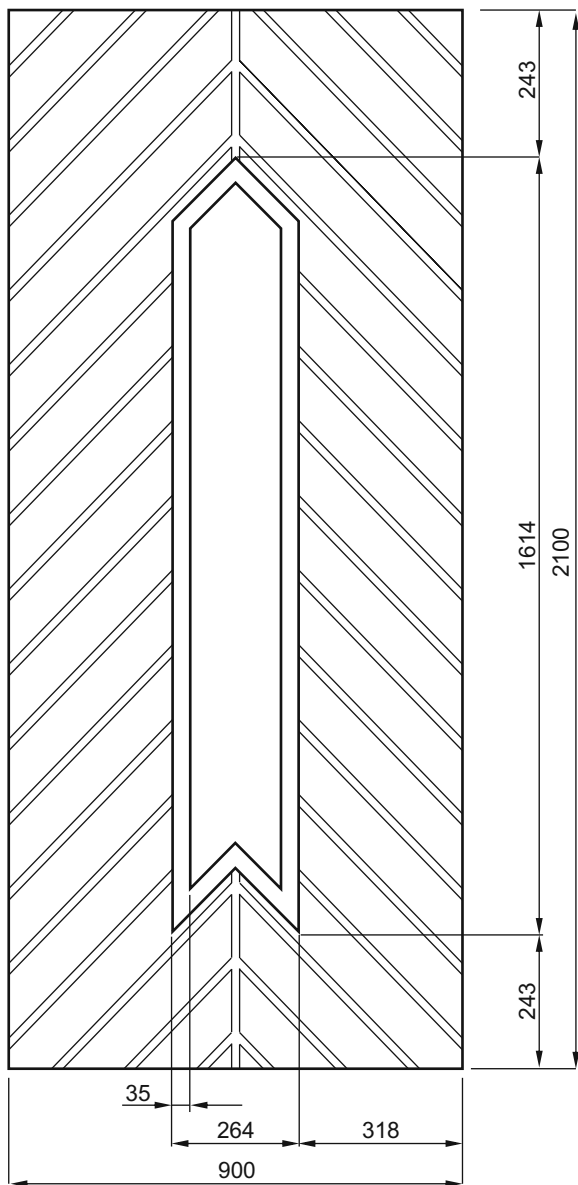

601 x 1714mm
 Minimální rozměry
 Min. size
 Min. Ausmass
 Dimension minimales

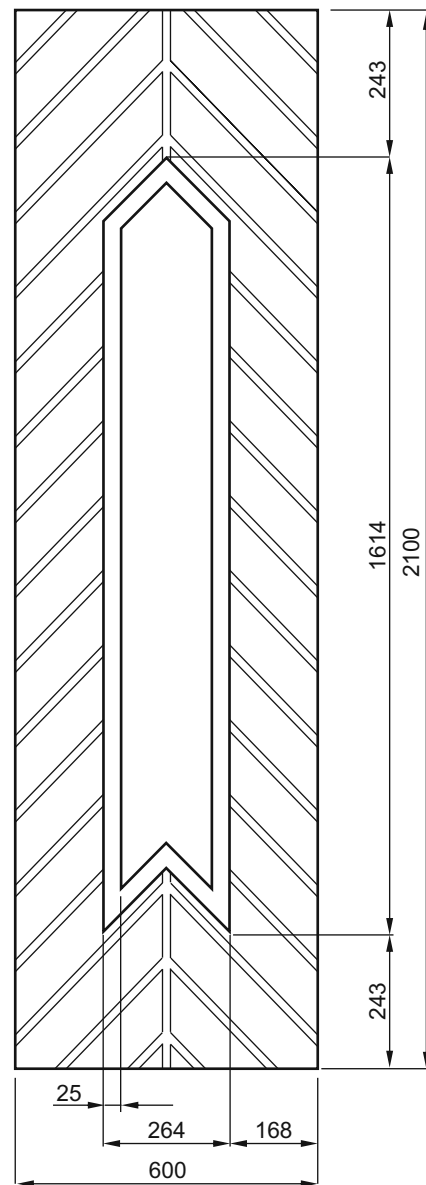

370 x 1714mm
 Minimální rozměry
 Min. size
 Min. Ausmass
 Dimension minimales

Skalice

Skalice 1/2

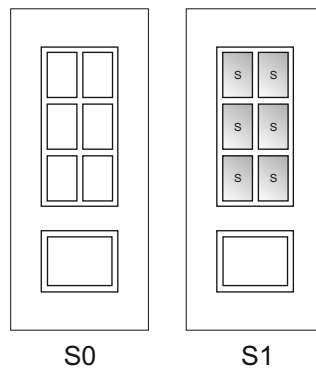
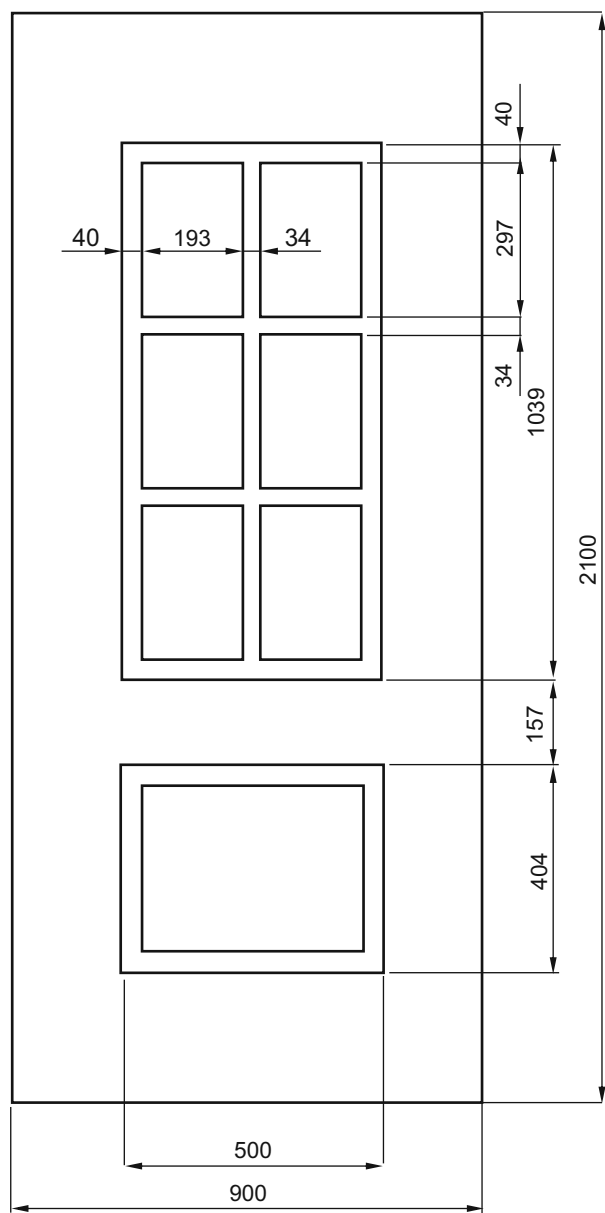

580 x 1680mm
 Minimální rozměry
 Min. size
 Min. Ausmass
 Dimension minimales

PRO PŘÍPAD POTŘEBY PŮLOVÉHO FORMÁTU
 JE DOPORUČENA KOMBINACE S VÝPLNÍ **ODRA 1/2**.

IF A HALF FORMAT NEEDED, A COMBINATION
 WITH THE DOOR PANEL **ODRA 1/2** IS RECOMMENDED.

FÜR DEN BEDARF EINES HALBFORMATES WIRD EINE
 KOMBINATION MIT DER FÜLLUNG **ODRA 1/2** EMPFOHLEN.

EN CAS DE BESOIN D'UN DEMI-FORMAT ON RECOMMANDE
 LA COMBINAISON DE PANNEAU DE PORTE **ODRA 1/2**.

Smaragd

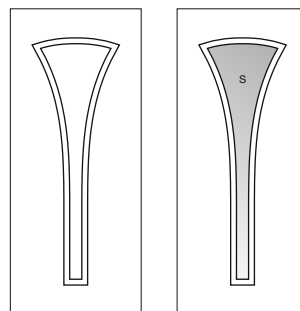
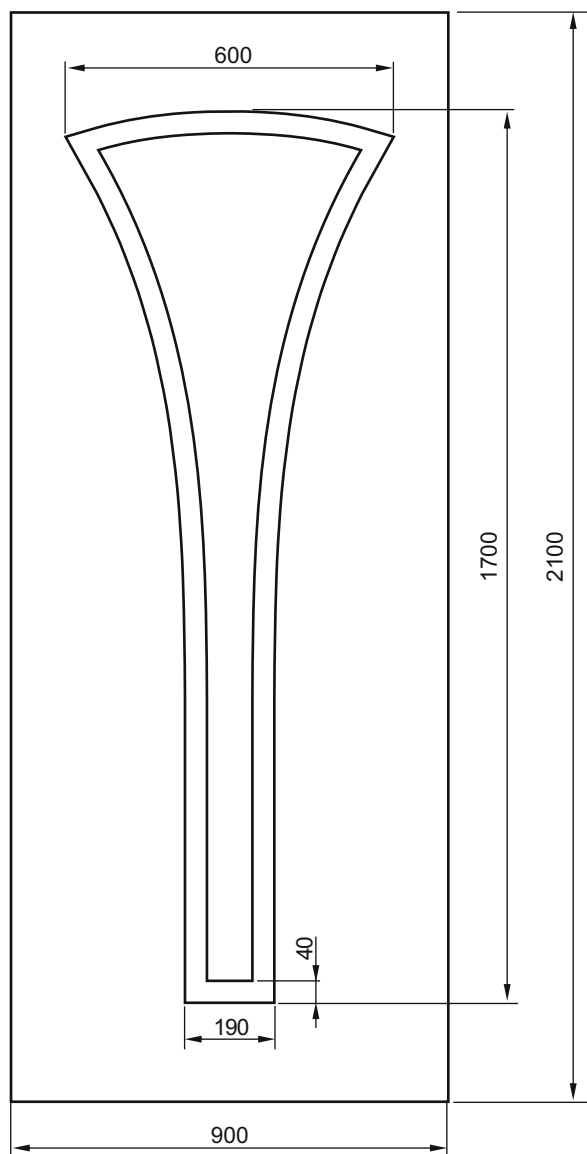

680 x 1780mm
Minimální rozměry
Min. size
Min. Ausmass
Dimension minimales

Spinel

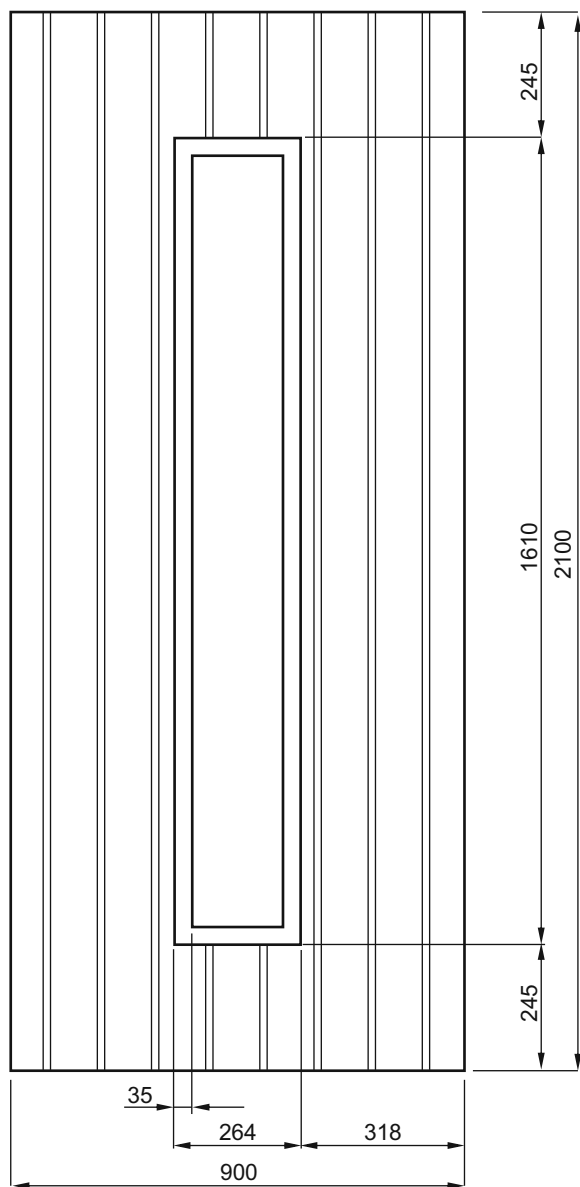

601 x 1710mm
 Minimální rozměry
 Min. size
 Min. Ausmass
 Dimension minimales



370 x 1710mm
 Minimální rozměry
 Min. size
 Min. Ausmass
 Dimension minimales

Stropnice

Stropnice 1/2

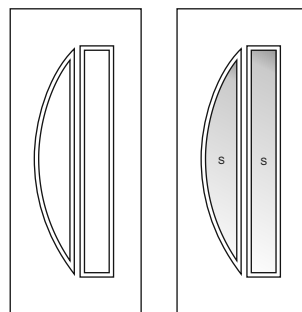
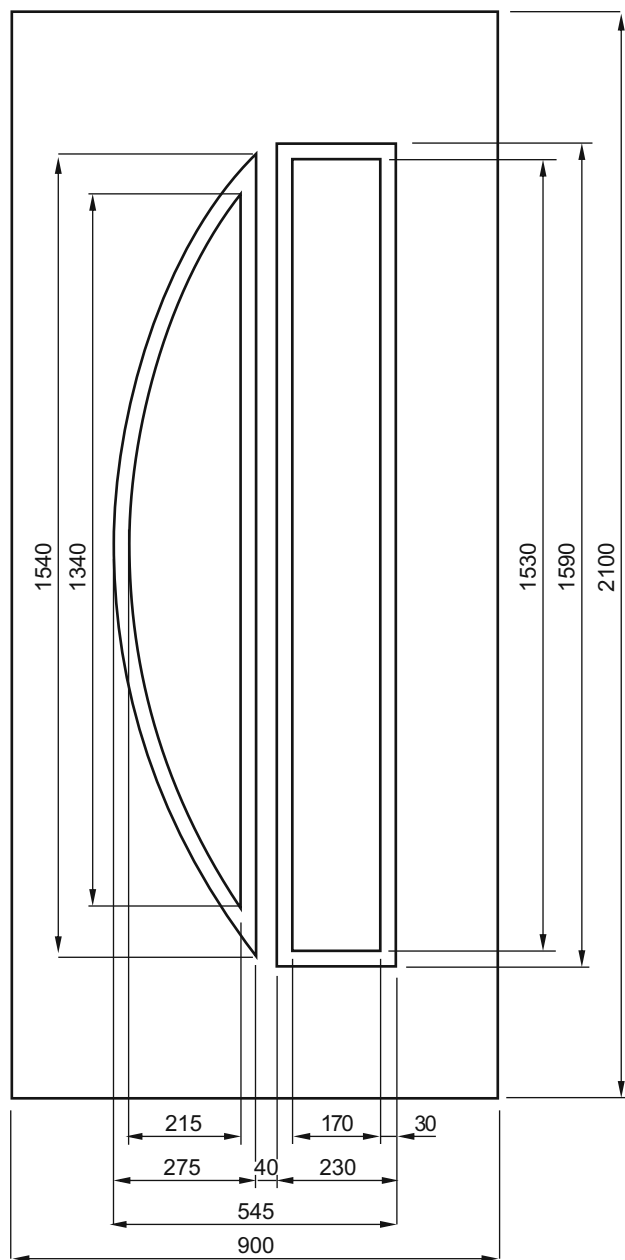

S0

S2

625 x 1670mm

Minimální rozměry

Min. size

Min. Ausmass

Dimension minimales

Pvitava

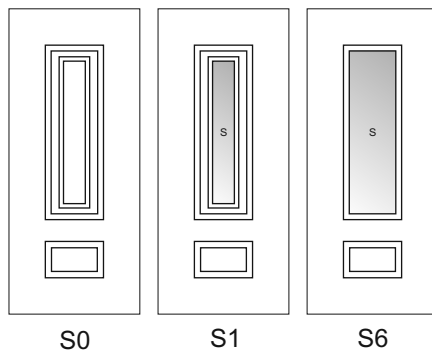
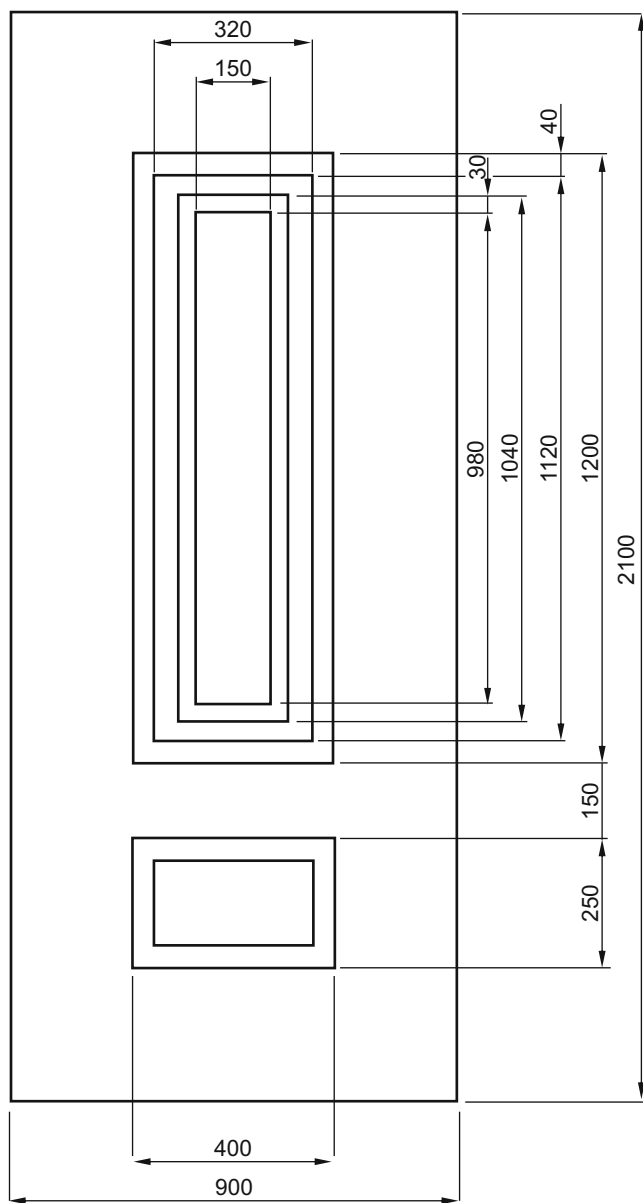

480 x 1720mm
 Minimální rozměry
 Min. size
 Min. Ausmass
 Dimension minimales

Topas

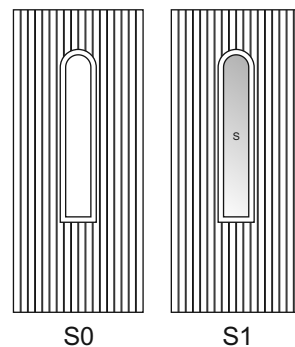
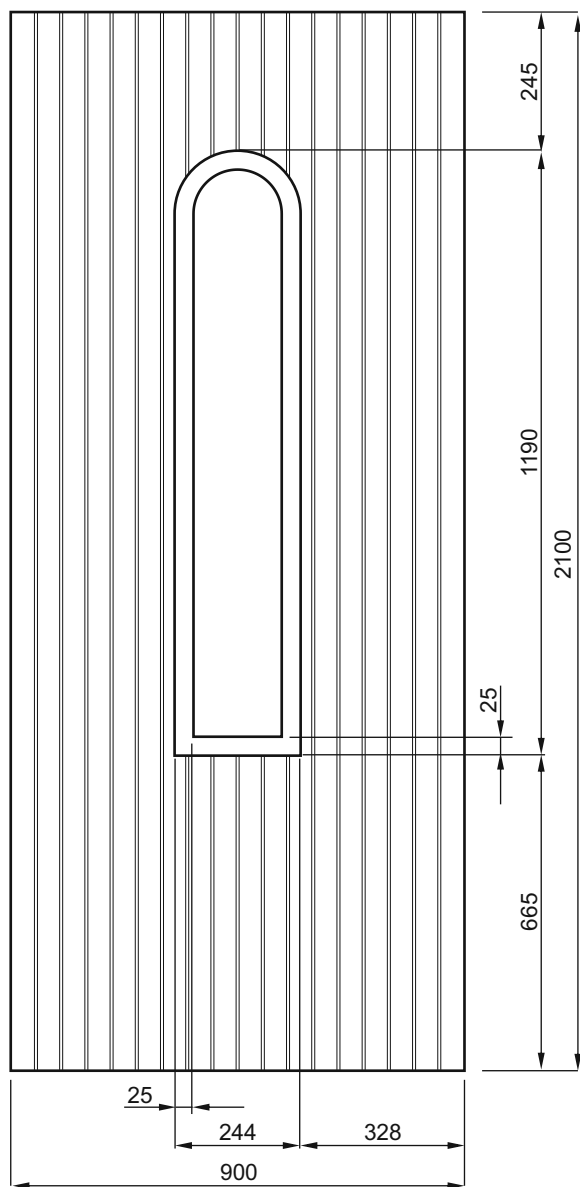

601 x 1700mm
 Minimální rozměry
 Min. size
 Min. Ausmass
 Dimension minimales

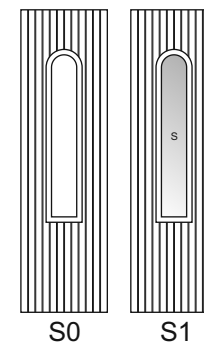
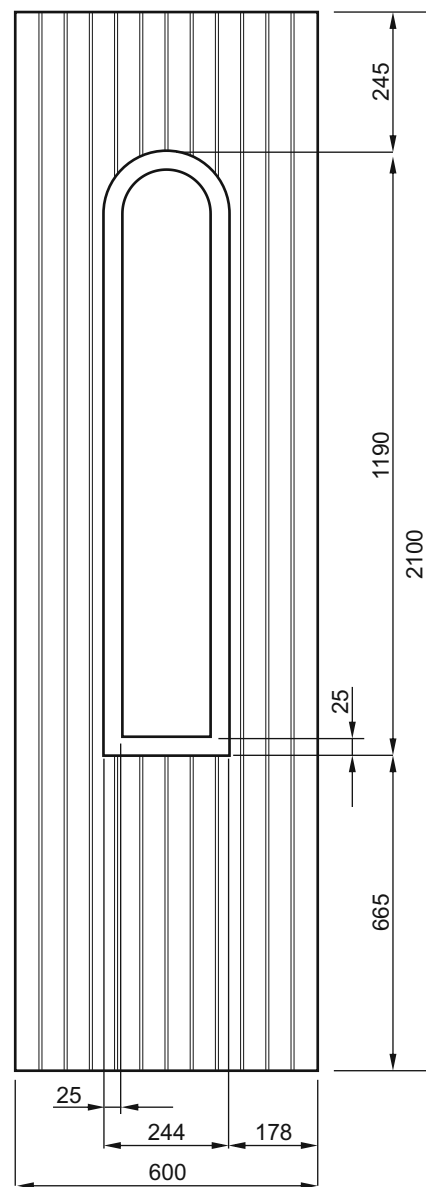

350 x 1700mm
 Minimální rozměry
 Min. size
 Min. Ausmass
 Dimension minimales

Trnava

Trnava 1/2

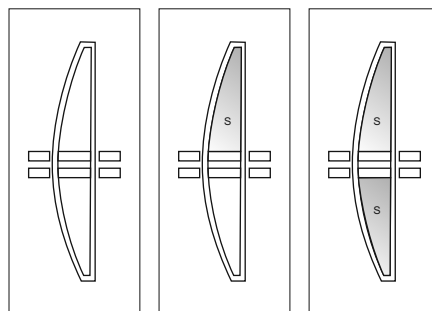
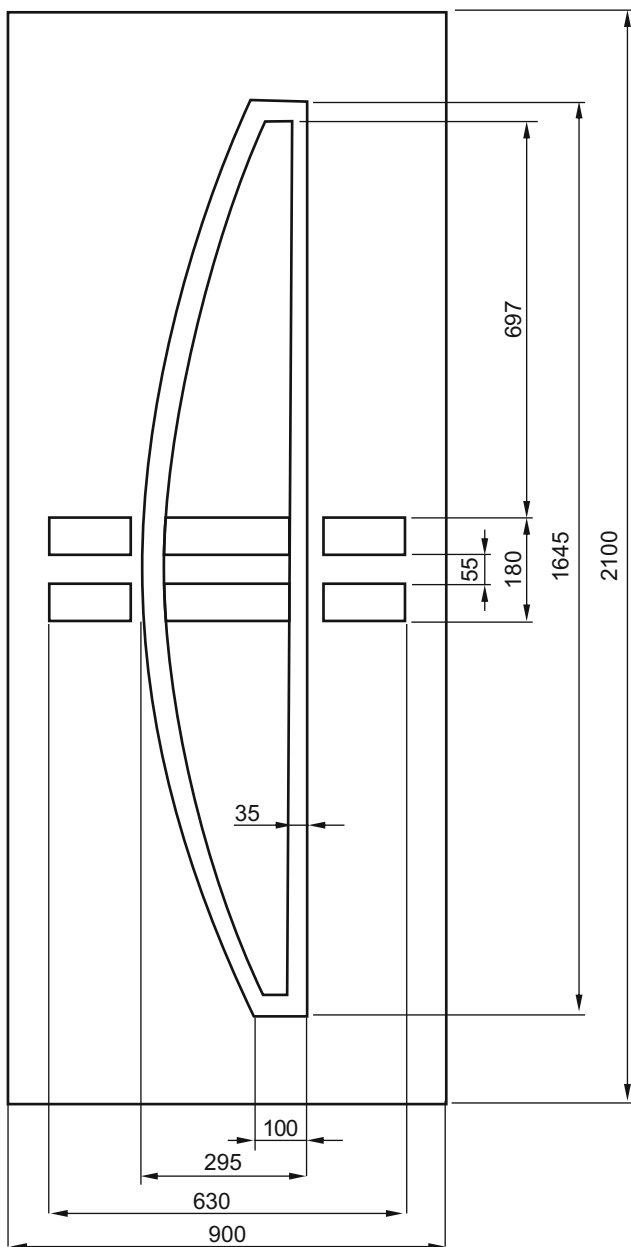

S0

S1

S2

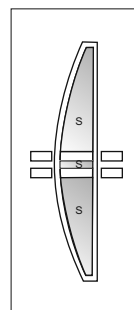

S3

710 x 1730mm
 Minimální rozměry
 Min. size
 Min. Ausmass
 Dimension minimales

Tyrkys

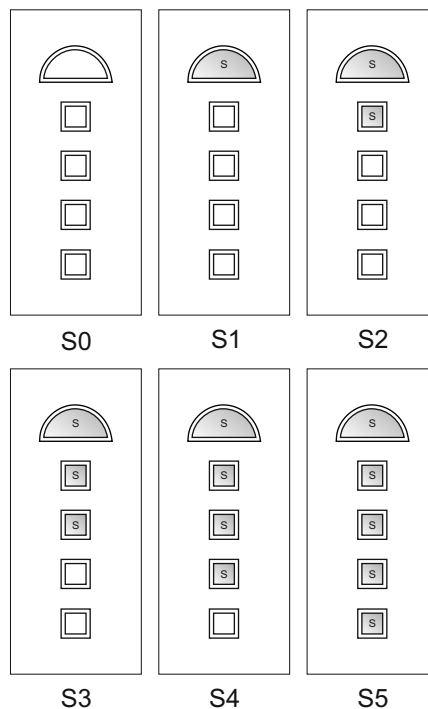
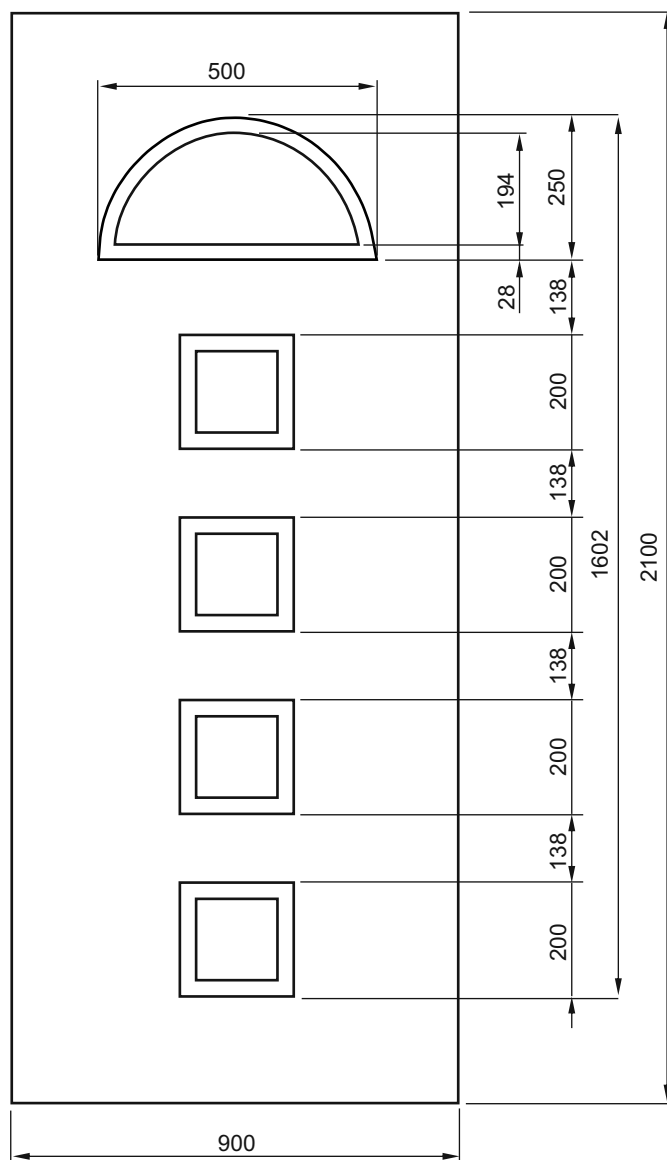

580 x 1680mm
 Minimální rozměry
 Min. size
 Min. Ausmass
 Dimension minimales

PRO PŘÍPAD POTŘEBY PŮLOVÉHO FORMÁTU
 JE DOPORUČENA KOMBINACE S VÝPLNÍ **RADBUZA 1/2**.

IF A HALF FORMAT NEEDED, A COMBINATION
 WITH THE DOOR PANEL **RADBUZA 1/2** IS RECOMMENDED.

FÜR DEN BEDARF EINES HALBFORMATES WIRD EINE
 KOMBINATION MIT DER FÜLLUNG **RADBUZA 1/2** EMPFOHLEN.

EN CAS DE BESOIN D'UN DEMI-FORMAT ON RECOMMANDE
 LA COMBINAISON DE PANNEAU DE PORTE **RADBUZA 1/2**.

Vltavín

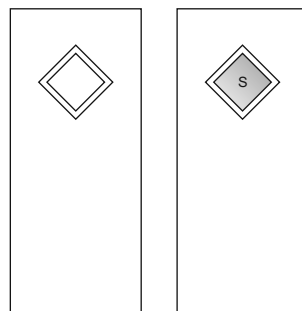
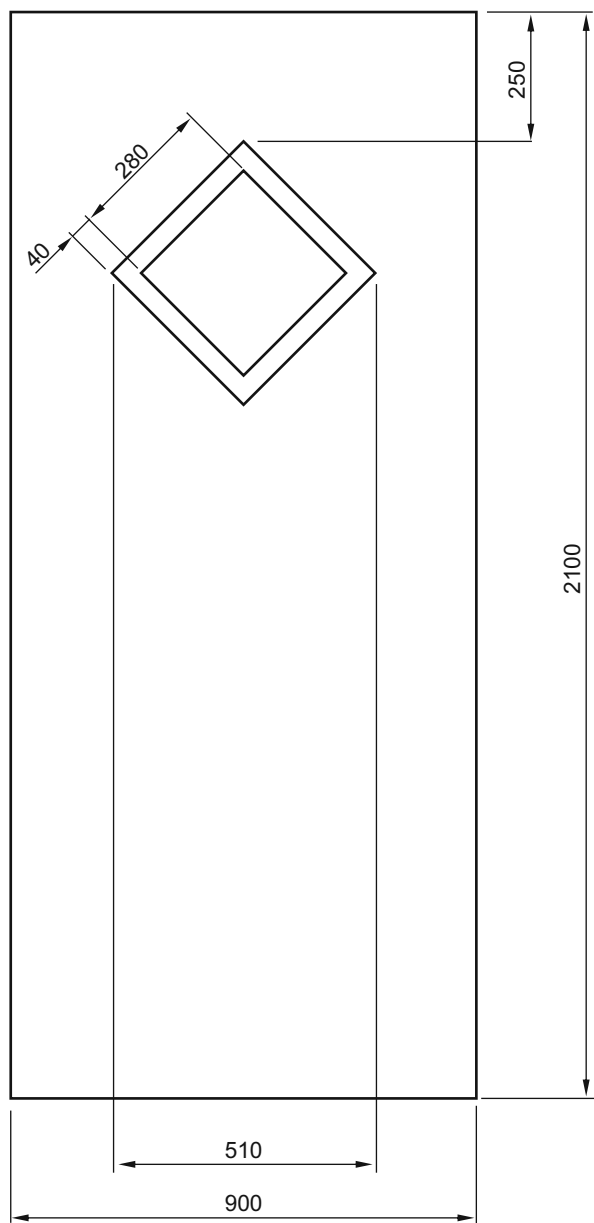

S0

S1

600 x 1700mm

Minimální rozměry

Min. size

Min. Ausmass

Dimension minimales

Vydra